

Tools Required:

- 5mm hex head screwdriver
- Special tool (provided by BEGA)
- Adjustable wrench

Overview:

LED Watts: 17.6W
 System Watts: 22.0W
 Controllability: 0-10V dimmable
 Weight: 72.8 lbs.
 Protection Class: IP65

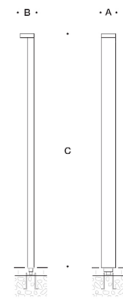

Dimensions

- A:** 9-1/4
- B:** 11
- C:** 137-3/4

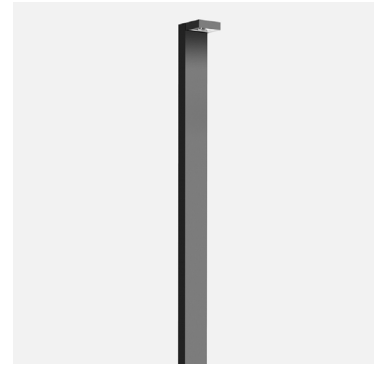

Notice to Installer:

1. See page 3 for specific product safety warnings.
2. Fixture may be damaged if connected to conduit systems that contain water - Article 300-5G of the National Electric Code requires that "Conduits or raceways through which moisture may contact energized live parts shall be sealed or plugged at either or both ends."
3. Fixture ships in two parts, the head and post will be in separate boxes.

79802 Anchor installation:

1. Anchor kit 79802 must be installed in concrete. This anchorage kit is buried below the finished grade. Attention to alignment, leveling, and location is required for proper installation See Figure 1.
2. Provide means to bring supply wiring to luminaire in accordance with local code. The template has a 2-1/8" x 4-1/2" conduit opening for conduit entry. Provide adequate foundation reinforcement for the intended load (by others).
3. Use template (Figure 2) and anchor bolts provided. Anchor bolts can be installed by either attaching template to concrete form, or by inserting anchor bolts into poured concrete. Ensure template and anchor bolts are leveled properly.
4. **IMPORTANT: Align and level template so the orientation of the rectangular conduit hole matches the desired orientation of the linear element (Figure 3).** Make sure anchor bolts will not protrude from concrete foundation more than 2-1/4".
5. Once the concrete footing is set, remove template and pull supply wiring through anchor base to a height of 36" to allow for wiring connections to be made later.
6. Attach anchor base to anchor bolts using leveling washers, lock washers, and hex nuts (provided).
7. Install finished grade.

Figure 1:

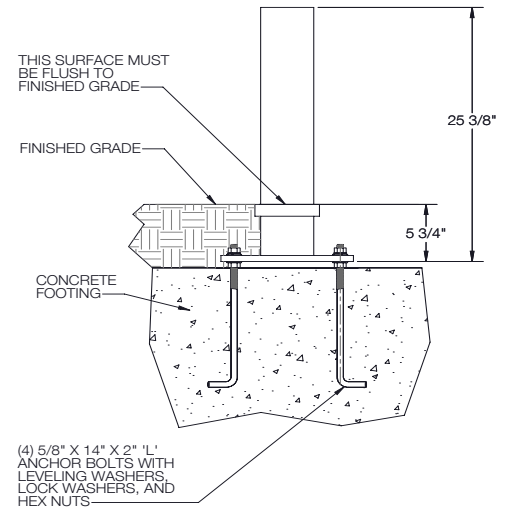

Figure 2:

84274 luminaire installation:

1. Fixture ships in two parts. Assemble top of luminaire and post together. Do not install post without head attached.
2. Route wires from luminaire head through post to access door for connections to be made later.
3. Secure head in place by tightening (2) 5mm hex head set screws on the back of the post.
4. Place post over anchor base ensuring the fixture is oriented correctly for desired light output direction.
5. Secure post to anchor base by tightening (8) 5mm hex head screws at the base of the post.
6. Open access door by using the special tool provided by BEGA.
7. Make supply wiring connections in the base of the post
 MAIN VOLTAGE SUPPLY WIRE TO BLACK LUMINAIRE WIRE
 NEUTRAL (COMMON) SUPPLY WIRE TO WHITE LUMINAIRE WIRE
 GREEN GROUND WIRE TO GREEN LUMINAIRE WIRE
 0-10V dimming (if applicable):
 DIM CONTROL WIRE (+) TO POSITIVE LUMINAIRE DIM CONTROL WIRE
 DIM CONTROL WIRE (-) TO NEGATIVE LUMINAIRE DIM CONTROL WIRE
8. Close access door.

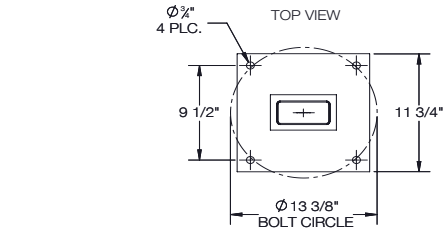
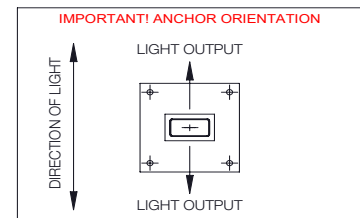

Figure 3:



Accessories

Please refer to the appropriate accessory installation sheet for further instruction when applicable.

Maintenance:

Clean regularly with solvent-free cleaner removing dirt and debris. Do not use high pressure cleaners.

Replacement Parts

See label inside of fixture for LED replacement part number.

Consult factory for all other replacement components.

Tools Required:

- 5mm hex head screwdriver
- Special tool (provided by BEGA)

Overview:

LED Watts: 17.6W
 System Watts: 22.0W
 Controllability: 0-10V dimmable
 Weight: 72.8 lbs.
 Protection Class: IP65

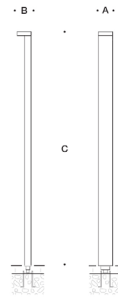

Dimensions

- A:** 9-1/4
- B:** 11
- C:** 137-3/4

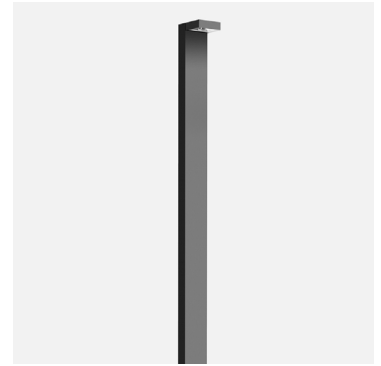

Notice to Installer:

1. See page 3 for specific product safety warnings.
2. Fixture may be damaged if connected to conduit systems that contain water - Article 300-5G of the National Electric Code requires that "Conduits or raceways through which moisture may contact energized live parts shall be sealed or plugged at either or both ends."
3. Fixture ships in two parts, the head and post will be in separate boxes.

Optional 71140 direct burial anchor installation:

1. Anchor kit 71140 is suitable for direct burial.
2. Proper drainage must be provided.
3. The size of the foundation and sub-base depends on the topography, condition of the soil, and wind load and must be determined by a structural engineer on site.
4. Remove the anchor plate from the inside of the anchor base. Attach plate to base by tightening (2) 5mm hex head screws. Anchor plate is designed to help provide stability during installation only. Hardware not provided.
5. Attach anchor base with anchor plate to sub base.
6. **IMPORTANT: Align and level anchor kit so the orientation of the rectangular conduit hole matches the desired orientation of the linear element (Figure 2).**
7. Bring in conduit through conduit entry in anchor base.
8. Bury anchor and finish surface.
9. Pull supply wiring through anchor base to a height of 36" to allow for wiring connections to be made later.

84274 luminaire installation:

1. Fixture ships in two parts. Assemble top of luminaire and post together. Do not install post without head attached.
2. Route wires from luminaire head through post to access door for connections to be made later.
3. Secure head in place by tightening (2) 5mm hex head set screws on the back of the post.
4. Place post over anchor base ensuring the fixture is oriented correctly for desired light output direction.
5. Secure post to anchor base by tightening (8) 5mm hex head screws at the base of the post.
6. Open access door by using the special tool provided by BEGA.
7. Make supply wiring connections in the base of the post
 MAIN VOLTAGE SUPPLY WIRE TO BLACK LUMINAIRE WIRE
 NEUTRAL (COMMON) SUPPLY WIRE TO WHITE LUMINAIRE WIRE
 GREEN GROUND WIRE TO GREEN LUMINAIRE WIRE
 0-10V dimming (if applicable):
 DIM CONTROL WIRE (+) TO POSITIVE LUMINAIRE DIM CONTROL WIRE
 DIM CONTROL WIRE (-) TO NEGATIVE LUMINAIRE DIM CONTROL WIRE
8. Close access door.

Figure 1:

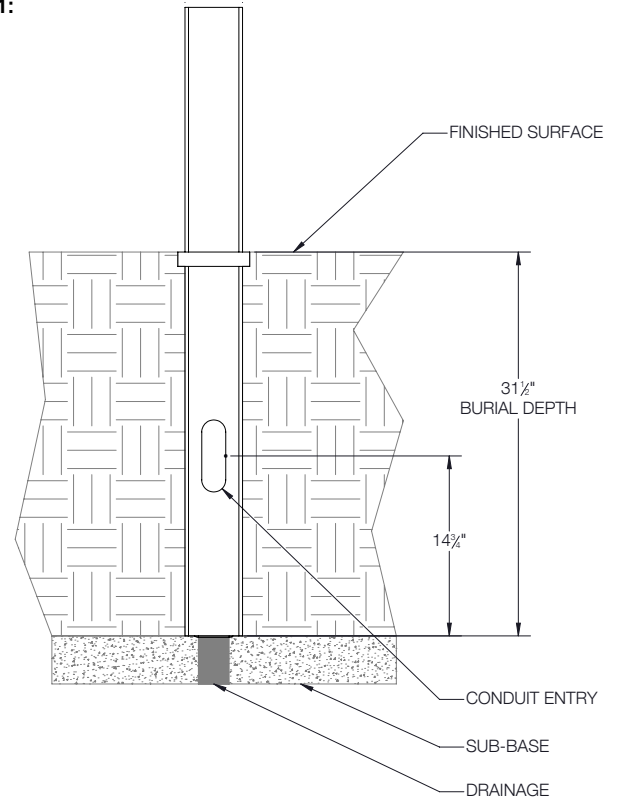
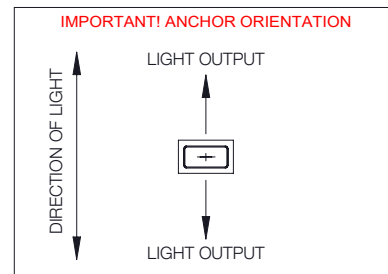

Figure 2:



Accessories

Please refer to the appropriate accessory installation sheet for further instruction when applicable.

Maintenance:

Clean regularly with solvent-free cleaner removing dirt and debris. Do not use high pressure cleaners.

Replacement Parts

See label inside of fixture for LED replacement part number.

Consult factory for all other replacement components.

Product Safety Warnings:

THIS PRODUCT MUST BE INSTALLED IN ACCORDANCE WITH THE APPLICABLE INSTALLATION CODE BY A PERSON FAMILIAR WITH THE CONSTRUCTION AND OPERATION OF THE PRODUCT AND THE HAZARDS INVOLVED. SUITABLE FOR MOUNTING WITHIN 1.2 m (4 ft) OF THE GROUND. SUITABLE FOR WET LOCATIONS. MIN 60°C SUPPLY CONDUCTORS.

CE PRODUIT DOIT ÊTRE INSTALLÉ SELON LE CODE D'INSTALLATION PERTINENT, PAR UNE PERSONNE QUI CONNAÎT BIEN LE PRODUIT ET SON FONCTIONNEMENT AINSI QUE LES RISQUES INHÉRENTS. PEUT ÊTRE INSTALLÉ À MOINS DE 1,2 m (4 pi) DU SOL. CONVIENT AUX EMPLACEMENTS MOUILLÉS. LES FILS D'ALIMENTATION 60°C MIN.