

NOTES: LUMINAIRE # 77 434 - SEE SPECIFICATIONS

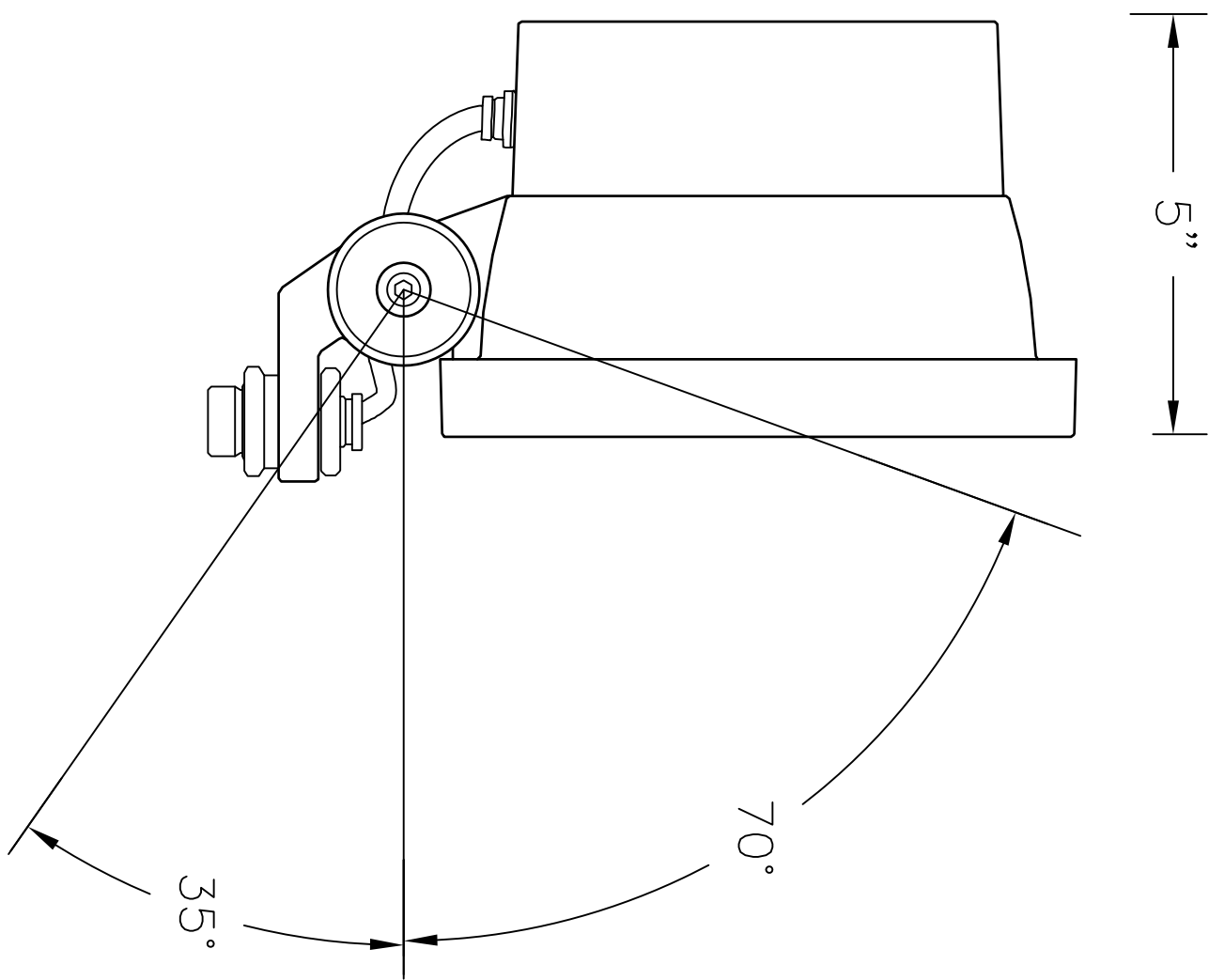
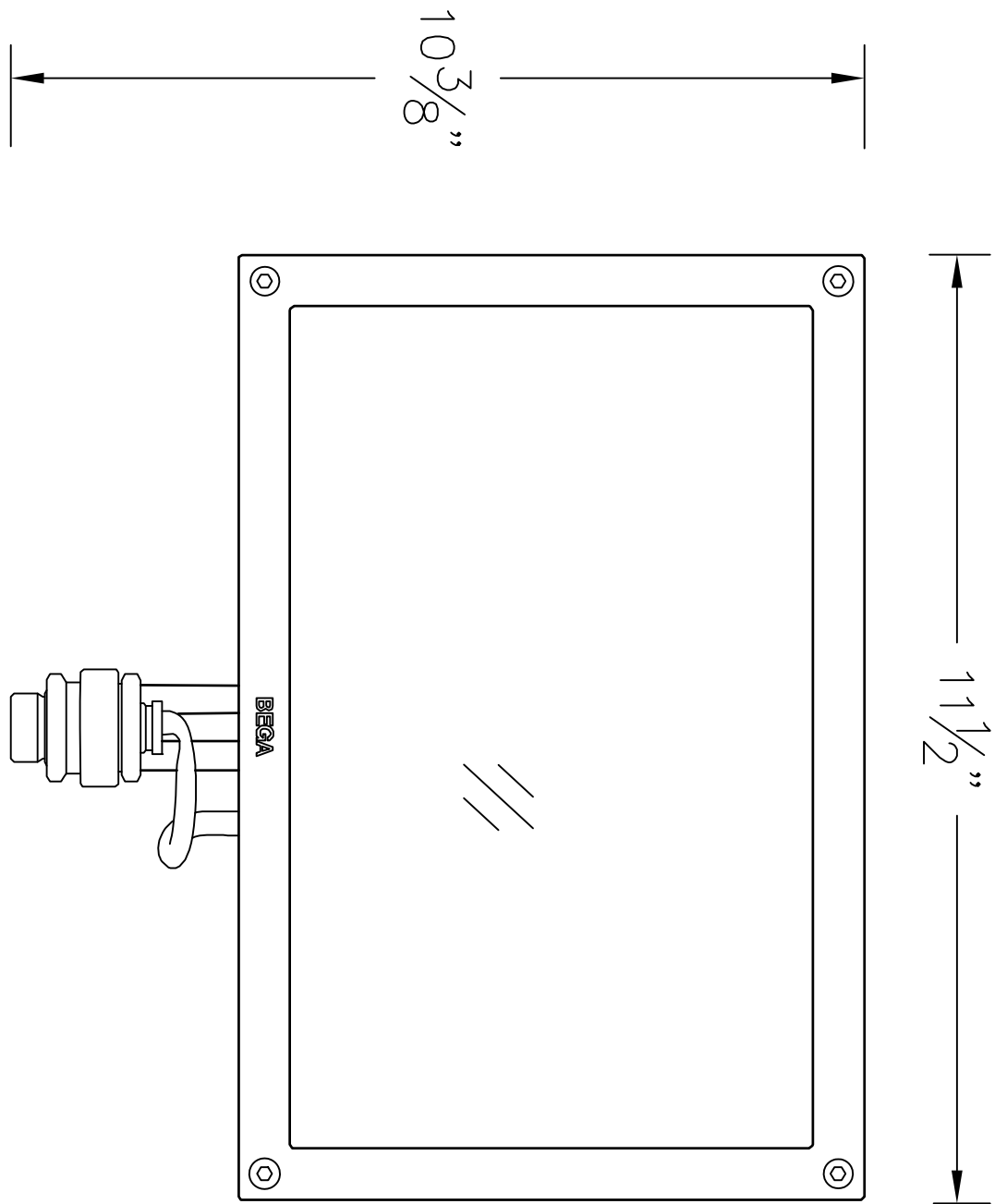

TYPE: _____

SUBMITTAL APPROVAL

APPROVED BY: _____

SIGNED: _____ DATE: _____

CAT NO.: 77 434

PROJECT: -

LOCATION: -

DRAWN: RA DATE: 6/7/2018 FILE NAME: 77434.dxf

BEGA

1000 Bega Way
Carpinteria, Ca. 93013
(805) 684-0533

REV.	DATE	DESCRIPTION

This print contains confidential information which is the property of BEGA U.S. By acceptance this information, the borrower agrees that it will not be used for any other purpose other than that which is was loaned.