

BEGA

File: 50684.2K4_BEGA_IES.ies

TEST: BE_50684.2K3
 TEST LAB: BEGA
 DATE: 11/26/2018
 LUMINAIRE: 50 684.2K4
 LAMP: 8.1W LED

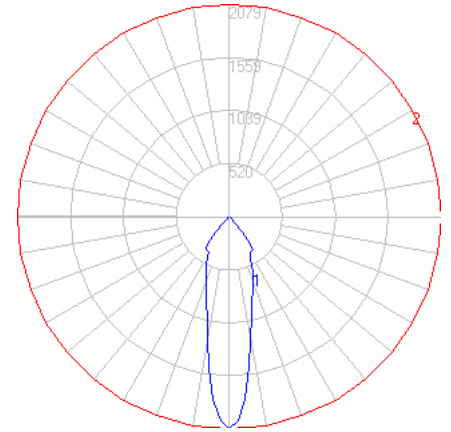

Characteristics

Lumens Per Lamp	N.A. (absolute)
Total Lamp Lumens	N.A. (absolute)
Luminaire Lumens	933
Total Luminaire Efficiency	N.A.
Luminaire Efficacy Rating (LER)	78
Total Luminaire Watts	12
Ballast Factor	1.00
CIE Type	Direct
Spacing Criterion (0-180)	0.42
Spacing Criterion (90-270)	0.42
Spacing Criterion (Diagonal)	0.56
Basic Luminous Shape	Circular
Luminous Length (0-180)	0.00 ft
Luminous Width (90-270)	0.33 ft (Diameter)
Luminous Height	0.00 ft

Zonal Lumen Summary

Zone	Lumens
0-10	152.01
10-20	245.29
20-30	240.42
30-40	225.33
40-50	43.92
50-60	11.73
60-70	9.26
70-80	4.19
80-90	0.79
90-100	0.00
100-110	0.00
110-120	0.00
120-130	0.00
130-140	0.00
140-150	0.00
150-160	0.00
160-170	0.00
170-180	0.00

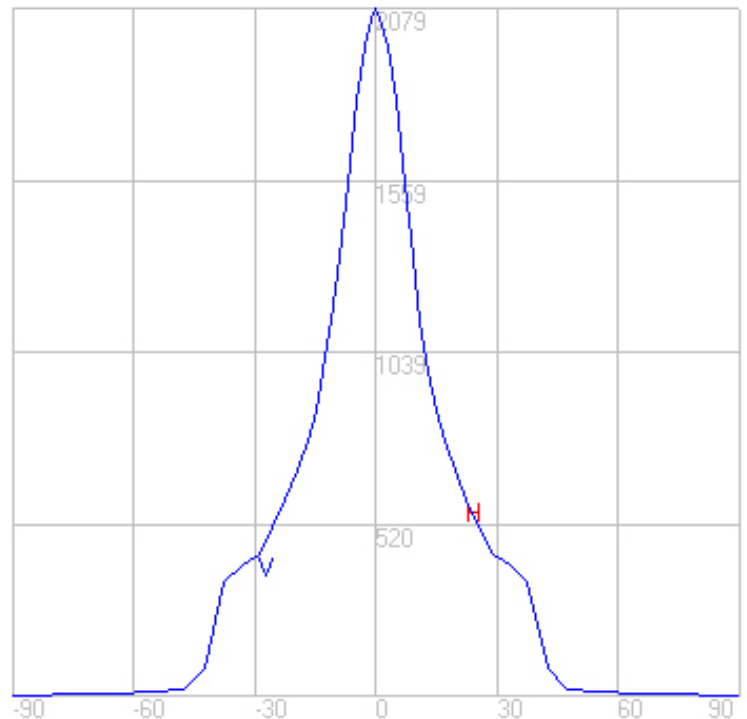
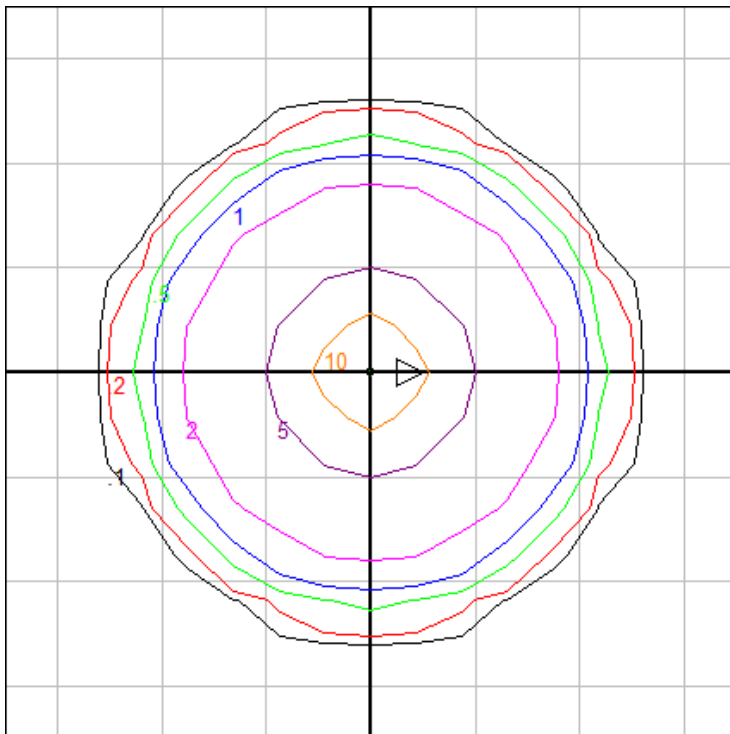

Mounting Height: 10 ft.

Grid Spacing: 4 ft.

In the interest of product improvement, BEGA reserves the right to make technical changes without notice.

BEGA 1000 Bega Way, Carpinteria, CA 93013 (805)684-0533 Fax (805)566-9474 www.bega-us.com © Copyright BEGA-US 2020

08/06/20

BEGA

File: 50684.2K35_BEGA_IES.ies

TEST: BE_50684.2K3
 TEST LAB: BEGA
 DATE: 11/26/2018
 LUMINAIRE: 50 684.2K35
 LAMP: 8.1W LED

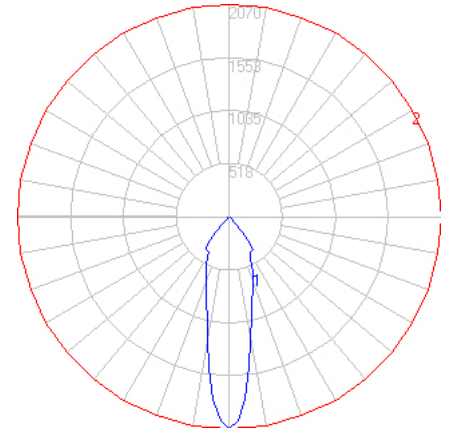
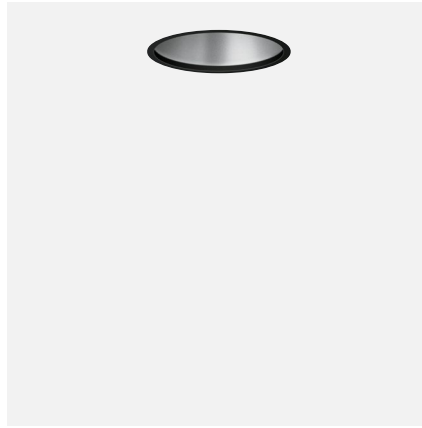

Characteristics

Lumens Per Lamp	N.A. (absolute)
Total Lamp Lumens	N.A. (absolute)
Luminaire Lumens	929
Total Luminaire Efficiency	N.A.
Luminaire Efficacy Rating (LER)	77
Total Luminaire Watts	12
Ballast Factor	1.00
CIE Type	Direct
Spacing Criterion (0-180)	0.42
Spacing Criterion (90-270)	0.42
Spacing Criterion (Diagonal)	0.56
Basic Luminous Shape	Circular
Luminous Length (0-180)	0.00 ft
Luminous Width (90-270)	0.33 ft (Diameter)
Luminous Height	0.00 ft

Zonal Lumen Summary

Zone	Lumens
0-10	151.41
10-20	244.33
20-30	239.47
30-40	224.45
40-50	43.75
50-60	11.68
60-70	9.22
70-80	4.17
80-90	0.78
90-100	0.00
100-110	0.00
110-120	0.00
120-130	0.00
130-140	0.00
140-150	0.00
150-160	0.00
160-170	0.00
170-180	0.00

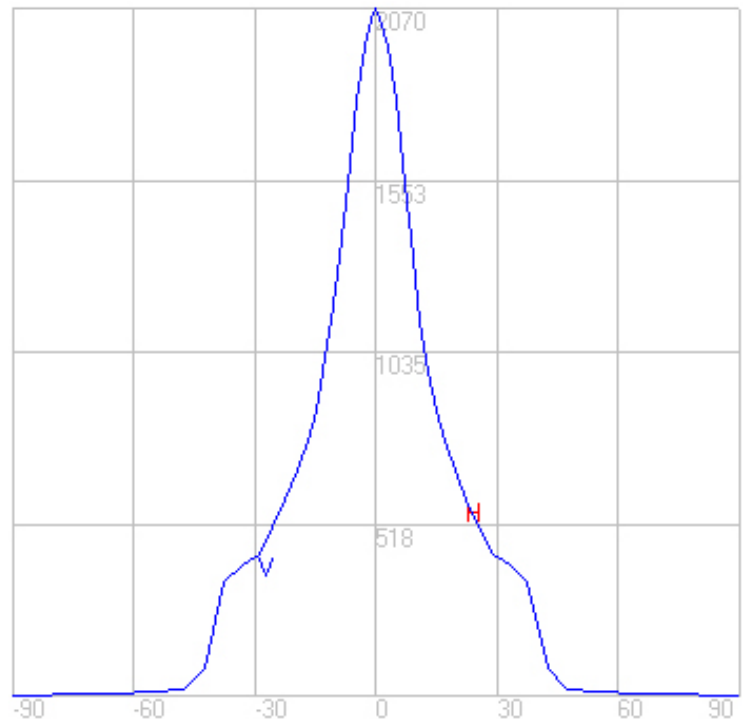
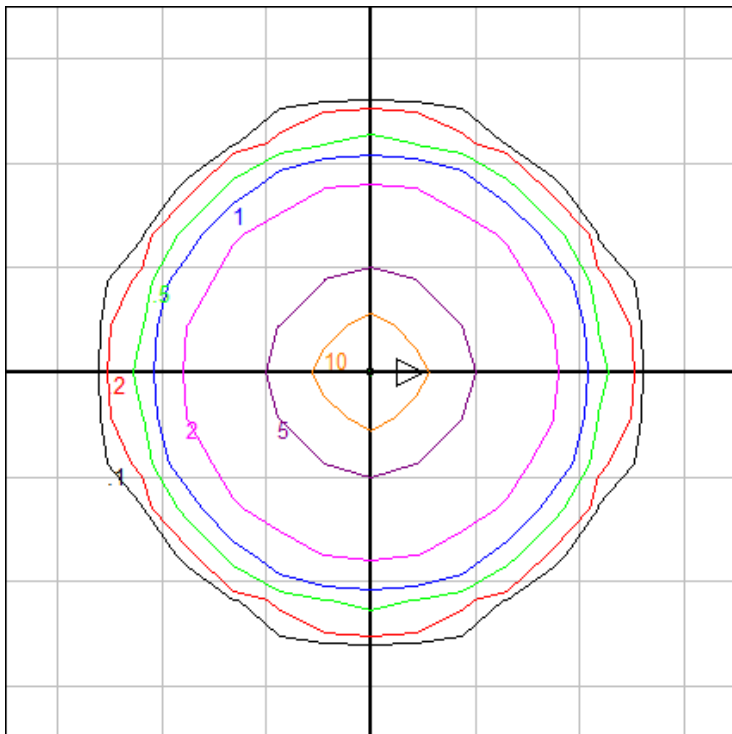

Mounting Height: 10 ft.

Grid Spacing: 4 ft.

In the interest of product improvement, BEGA reserves the right to make technical changes without notice.

BEGA 1000 Bega Way, Carpinteria, CA 93013 (805)684-0533 Fax (805)566-9474 www.bega-us.com © Copyright BEGA-US 2020

08/06/20

BEGA

File: 50684.2K3_BEGA_IES.ies

TEST: BE_50684.2K3
 TEST LAB: BEGA
 DATE: 11/26/2018
 LUMINAIRE: 50 684.2K3
 LAMP: 8.1W LED

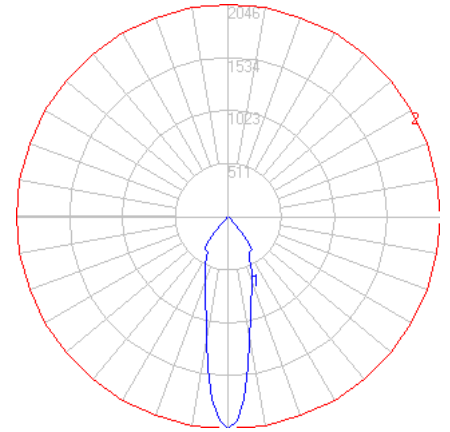

Characteristics

Lumens Per Lamp	N.A. (absolute)
Total Lamp Lumens	N.A. (absolute)
Luminaire Lumens	918
Total Luminaire Efficiency	N.A.
Luminaire Efficacy Rating (LER)	77
Total Luminaire Watts	12
Ballast Factor	1.00
CIE Type	Direct
Spacing Criterion (0-180)	0.42
Spacing Criterion (90-270)	0.42
Spacing Criterion (Diagonal)	0.56
Basic Luminous Shape	Circular
Luminous Length (0-180)	0.00 ft
Luminous Width (90-270)	0.33 ft (Diameter)
Luminous Height	0.00 ft

Zonal Lumen Summary

Zone	Lumens
0-10	149.62
10-20	241.43
20-30	236.63
30-40	221.79
40-50	43.23
50-60	11.54
60-70	9.11
70-80	4.12
80-90	0.77
90-100	0.00
100-110	0.00
110-120	0.00
120-130	0.00
130-140	0.00
140-150	0.00
150-160	0.00
160-170	0.00
170-180	0.00

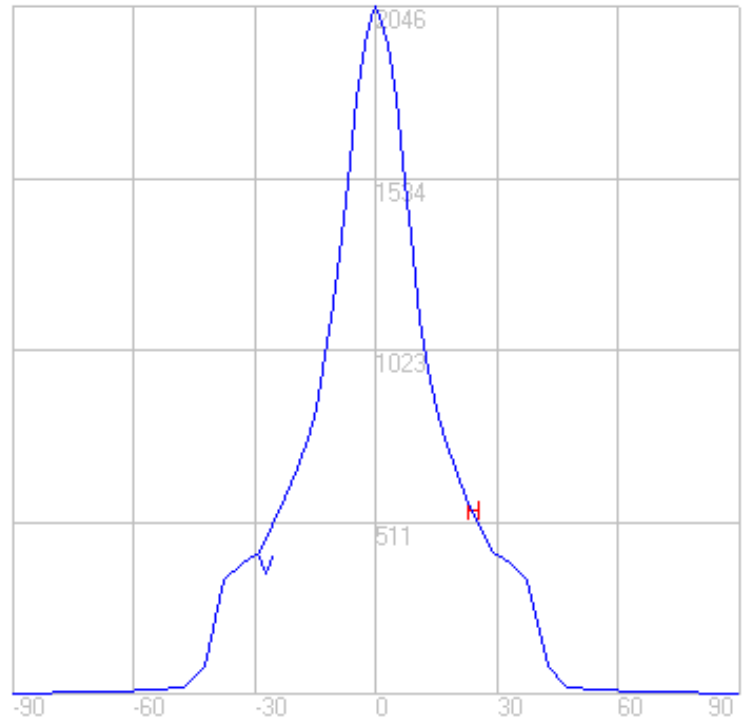
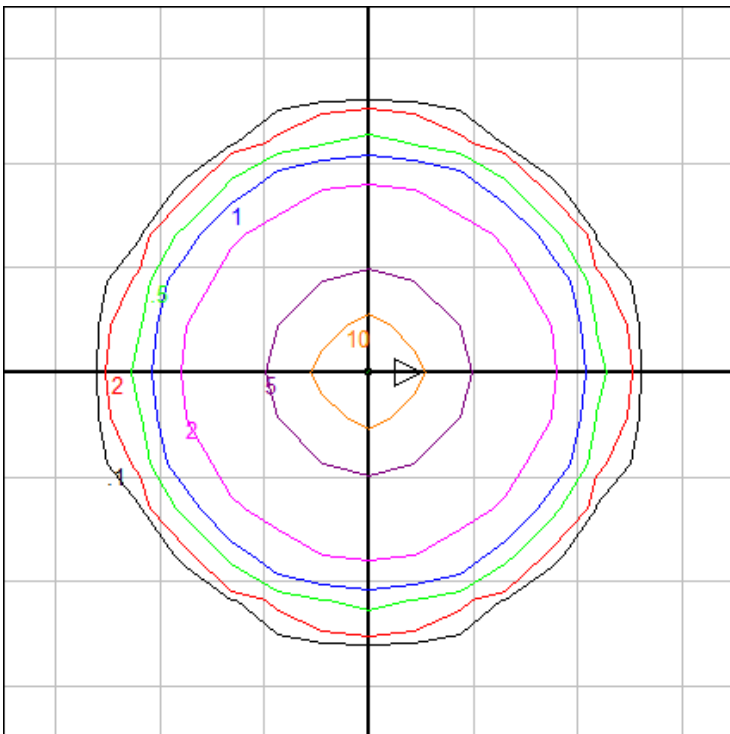

Mounting Height: 10 ft.

Grid Spacing: 4 ft.

In the interest of product improvement, BEGA reserves the right to make technical changes without notice.

BEGA

File: 50684.2K27_BEGA_IES.ies

TEST: BE_50684.2K3
 TEST LAB: BEGA
 DATE: 11/26/2018
 LUMINAIRE: 50 684.2K27
 LAMP: 8.1W LED

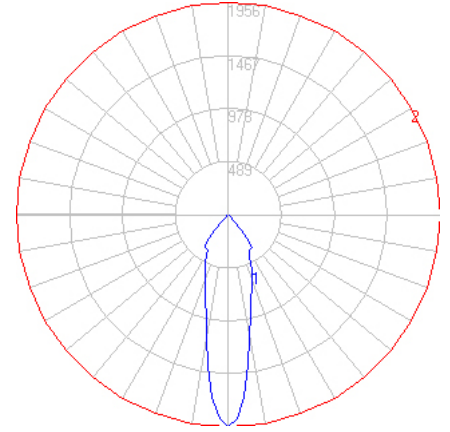

Characteristics

Lumens Per Lamp	N.A. (absolute)
Total Lamp Lumens	N.A. (absolute)
Luminaire Lumens	878
Total Luminaire Efficiency	N.A.
Luminaire Efficacy Rating (LER)	73
Total Luminaire Watts	12
Ballast Factor	1.00
CIE Type	Direct
Spacing Criterion (0-180)	0.42
Spacing Criterion (90-270)	0.42
Spacing Criterion (Diagonal)	0.56
Basic Luminous Shape	Circular
Luminous Length (0-180)	0.00 ft
Luminous Width (90-270)	0.33 ft (Diameter)
Luminous Height	0.00 ft

Zonal Lumen Summary

Zone	Lumens
0-10	143.03
10-20	230.81
20-30	226.22
30-40	212.03
40-50	41.33
50-60	11.03
60-70	8.71
70-80	3.94
80-90	0.74
90-100	0.00
100-110	0.00
110-120	0.00
120-130	0.00
130-140	0.00
140-150	0.00
150-160	0.00
160-170	0.00
170-180	0.00

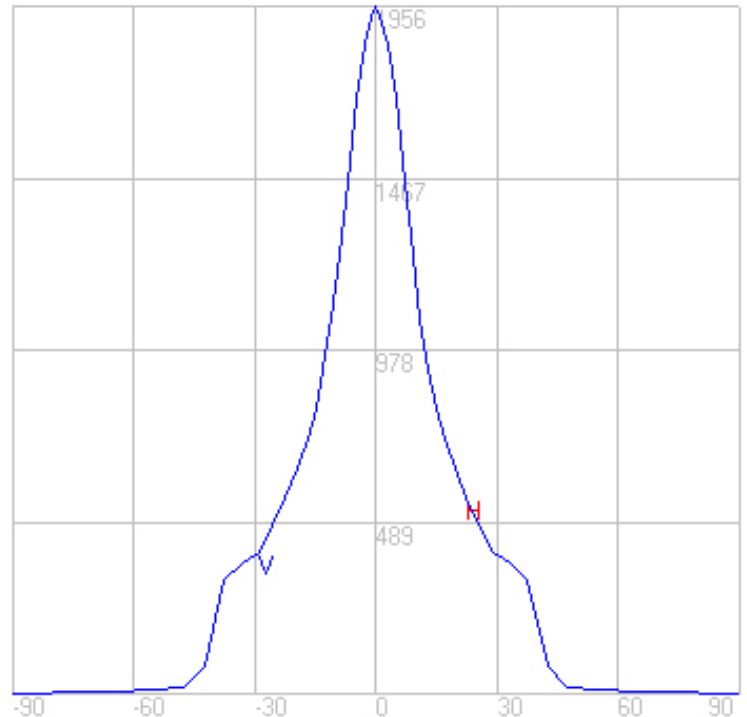
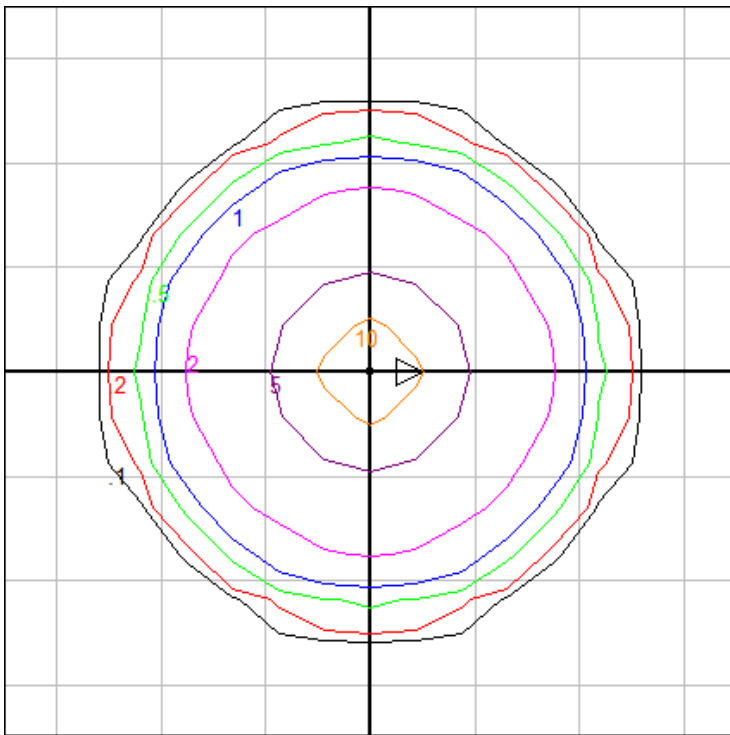

Mounting Height: 10 ft.

Grid Spacing: 4 ft.

In the interest of product improvement, BEGA reserves the right to make technical changes without notice.

BEGA 1000 Bega Way, Carpinteria, CA 93013 (805)684-0533 Fax (805)566-9474 www.bega-us.com © Copyright BEGA-US 2020

08/06/20

BEGA

File: 50684.4K4_BEGA_IES.ies

TEST: BE_50684.4K3
 TEST LAB: BEGA
 DATE: 11/26/2018
 LUMINAIRE: 50 684.4K4
 LAMP: 8.1W LED

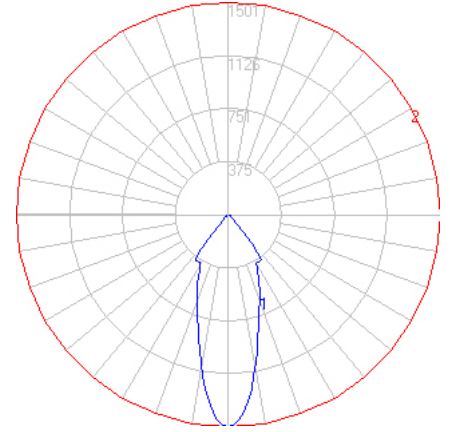
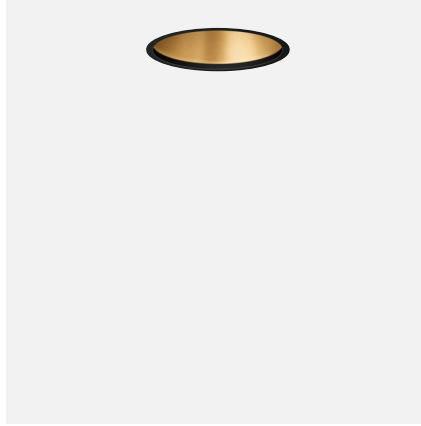

Characteristics

Lumens Per Lamp	N.A. (absolute)
Total Lamp Lumens	N.A. (absolute)
Luminaire Lumens	876
Total Luminaire Efficiency	N.A.
Luminaire Efficacy Rating (LER)	73
Total Luminaire Watts	12
Ballast Factor	1.00
CIE Type	Direct
Spacing Criterion (0-180)	0.54
Spacing Criterion (90-270)	0.54
Spacing Criterion (Diagonal)	0.68
Basic Luminous Shape	Circular
Luminous Length (0-180)	0.00 ft
Luminous Width (90-270)	0.33 ft (Diameter)
Luminous Height	0.00 ft

Zonal Lumen Summary

Zone	Lumens
0-10	102.03
10-20	240.63
20-30	245.31
30-40	208.95
40-50	56.33
50-60	11.98
60-70	6.71
70-80	3.21
80-90	0.41
90-100	0.00
100-110	0.00
110-120	0.00
120-130	0.00
130-140	0.00
140-150	0.00
150-160	0.00
160-170	0.00
170-180	0.00

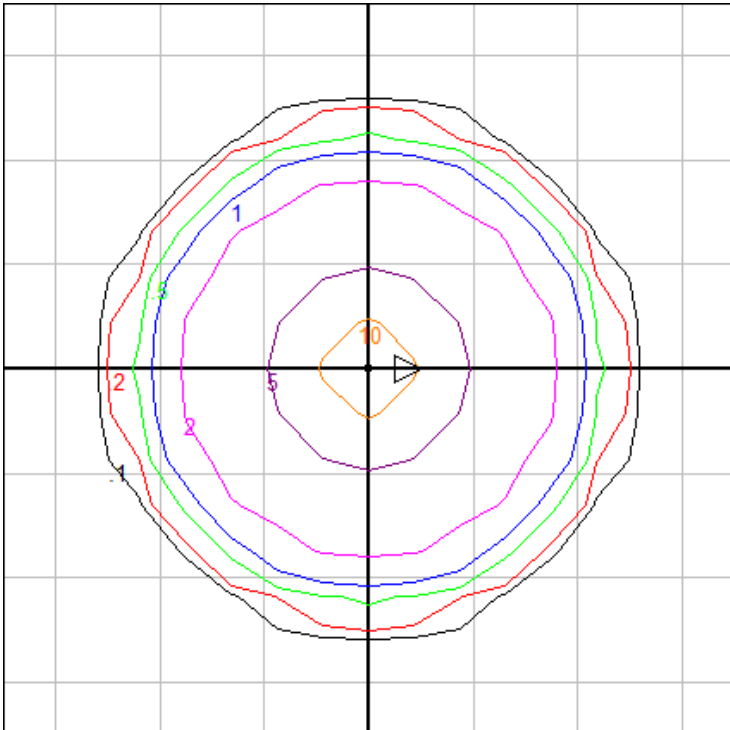

Mounting Height: 10 ft.

Grid Spacing: 4 ft.

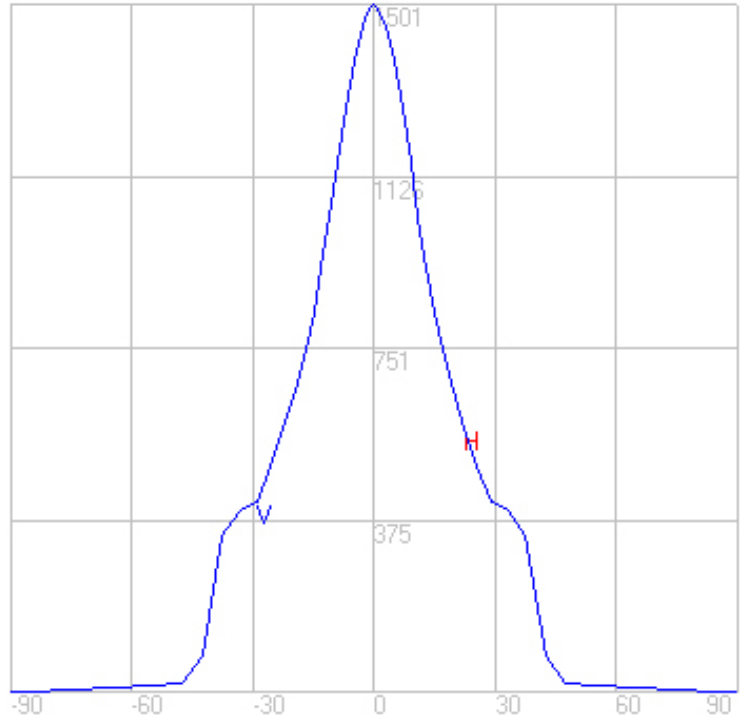

In the interest of product improvement, BEGA reserves the right to make technical changes without notice.

BEGA 1000 Bega Way, Carpinteria, CA 93013 (805)684-0533 Fax (805)566-9474 www.bega-us.com © Copyright BEGA-US 2020

08/06/20

BEGA

File: 50684.4K3_BEGA_IES.ies

TEST: BE_50684.4K3
 TEST LAB: BEGA
 DATE: 11/26/2018
 LUMINAIRE: 50 684.4K3
 LAMP: 8.1W LED

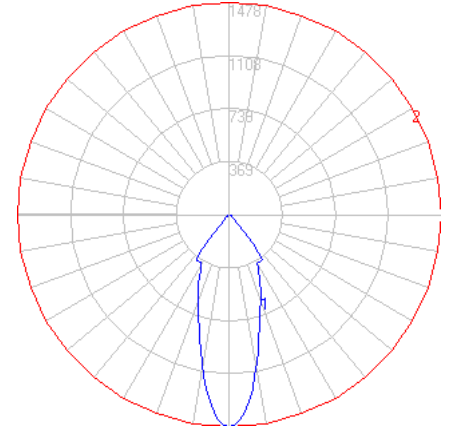
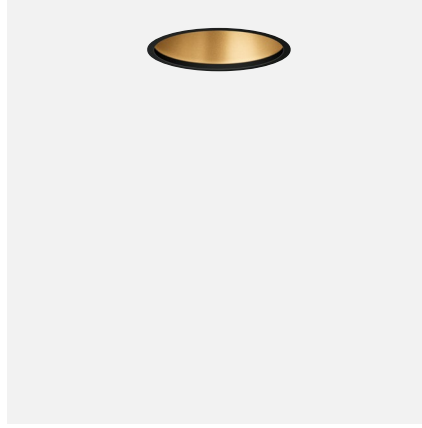

Characteristics

Lumens Per Lamp	N.A. (absolute)
Total Lamp Lumens	N.A. (absolute)
Luminaire Lumens	862
Total Luminaire Efficiency	N.A.
Luminaire Efficacy Rating (LER)	72
Total Luminaire Watts	12
Ballast Factor	1.00
CIE Type	Direct
Spacing Criterion (0-180)	0.54
Spacing Criterion (90-270)	0.54
Spacing Criterion (Diagonal)	0.68
Basic Luminous Shape	Circular
Luminous Length (0-180)	0.00 ft
Luminous Width (90-270)	0.33 ft (Diameter)
Luminous Height	0.00 ft

Zonal Lumen Summary

Zone	Lumens
0-10	100.42
10-20	236.84
20-30	241.45
30-40	205.66
40-50	55.45
50-60	11.79
60-70	6.60
70-80	3.16
80-90	0.41
90-100	0.00
100-110	0.00
110-120	0.00
120-130	0.00
130-140	0.00
140-150	0.00
150-160	0.00
160-170	0.00
170-180	0.00

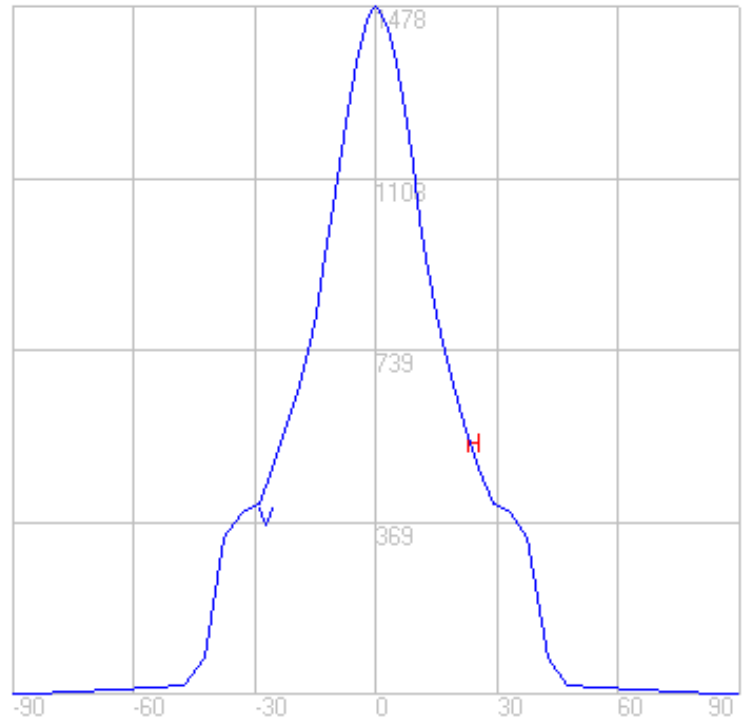
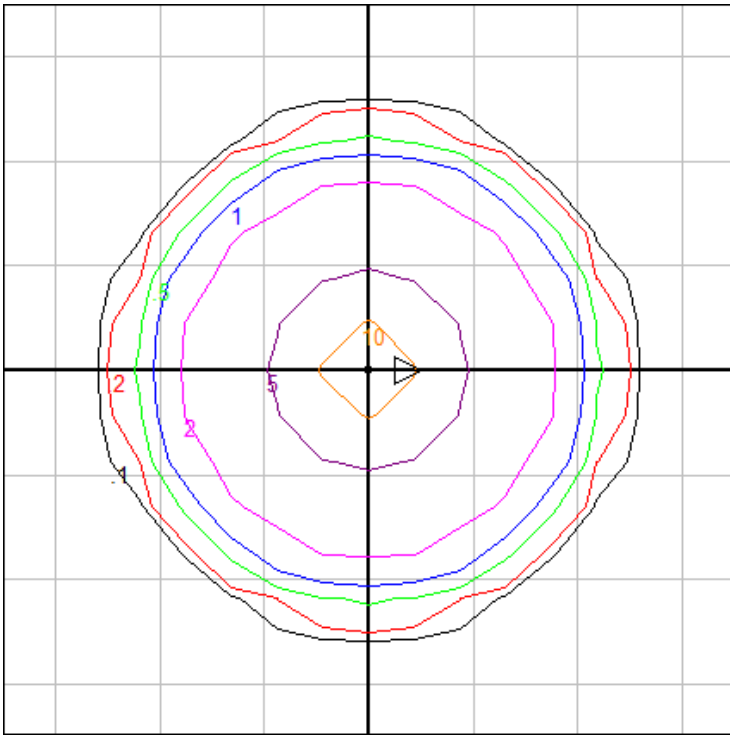

Mounting Height: 10 ft.

Grid Spacing: 4 ft.

In the interest of product improvement, BEGA reserves the right to make technical changes without notice.

BEGA 1000 Bega Way, Carpinteria, CA 93013 (805)684-0533 Fax (805)566-9474 www.bega-us.com © Copyright BEGA-US 2020

08/06/20

BEGA

File: 50684.4K27_BEGA_IES.ies

TEST: BE_50684.4K3
 TEST LAB: BEGA
 DATE: 11/26/2018
 LUMINAIRE: 50 684.4K27
 LAMP: 8.1W LED

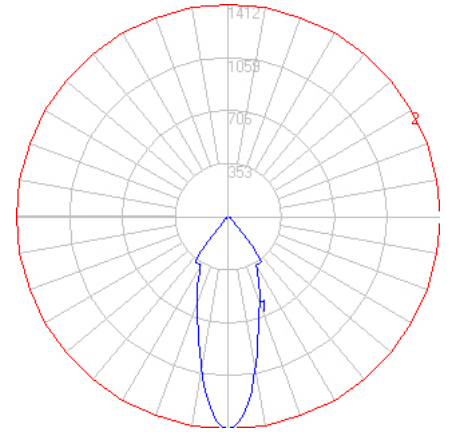
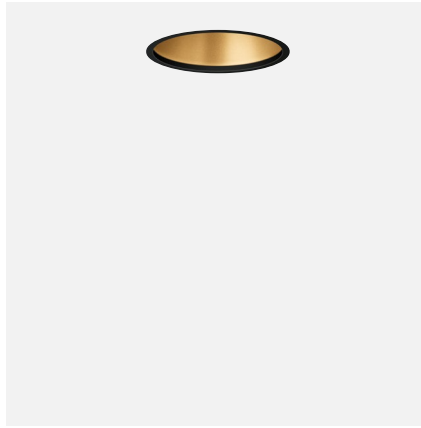

Characteristics

Lumens Per Lamp	N.A. (absolute)
Total Lamp Lumens	N.A. (absolute)
Luminaire Lumens	824
Total Luminaire Efficiency	N.A.
Luminaire Efficacy Rating (LER)	69
Total Luminaire Watts	12
Ballast Factor	1.00
CIE Type	Direct
Spacing Criterion (0-180)	0.54
Spacing Criterion (90-270)	0.54
Spacing Criterion (Diagonal)	0.68
Basic Luminous Shape	Circular
Luminous Length (0-180)	0.00 ft
Luminous Width (90-270)	0.33 ft (Diameter)
Luminous Height	0.00 ft

Zonal Lumen Summary

Zone	Lumens
0-10	96.00
10-20	226.42
20-30	230.83
30-40	196.61
40-50	53.01
50-60	11.27
60-70	6.31
70-80	3.02
80-90	0.39
90-100	0.00
100-110	0.00
110-120	0.00
120-130	0.00
130-140	0.00
140-150	0.00
150-160	0.00
160-170	0.00
170-180	0.00

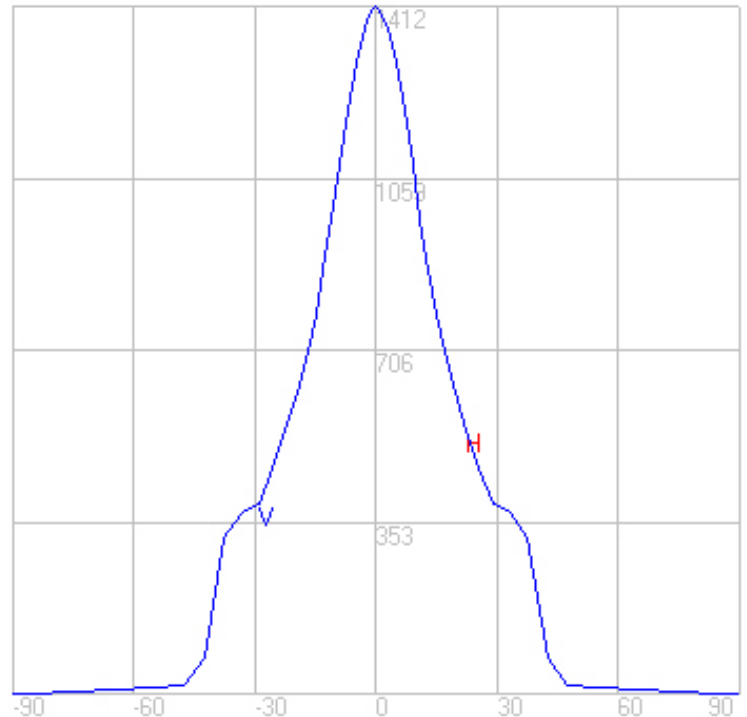
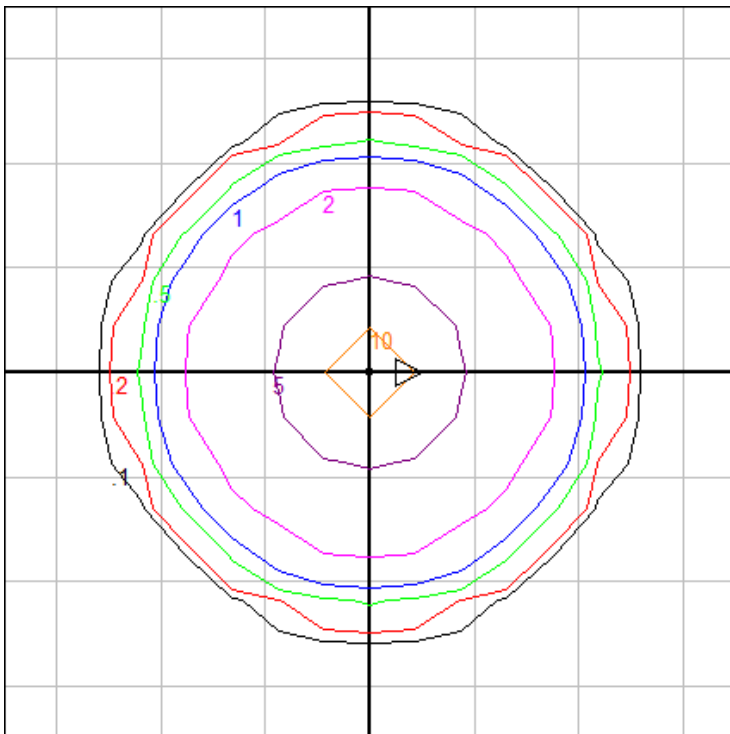

Mounting Height: 10 ft.

Grid Spacing: 4 ft.

In the interest of product improvement, BEGA reserves the right to make technical changes without notice.

BEGA 1000 Bega Way, Carpinteria, CA 93013 (805)684-0533 Fax (805)566-9474 www.bega-us.com © Copyright BEGA-US 2020

08/06/20

BEGA

File: 50684.6K4_BEGA_IES.ies

TEST: BE_50684.6K3
 TEST LAB: BEGA
 DATE: 11/26/2018
 LUMINAIRE: 50 684.6K4
 LAMP: 8.1W LED

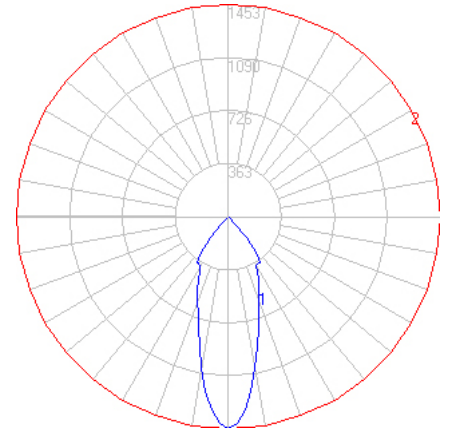
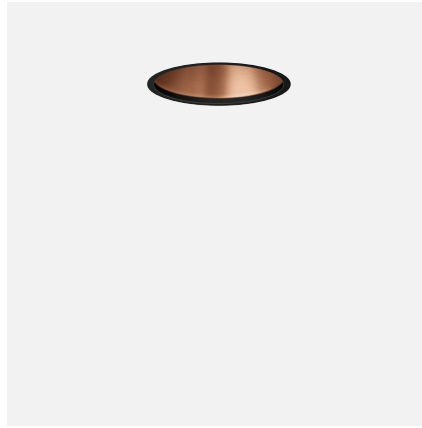

Characteristics

Lumens Per Lamp	N.A. (absolute)
Total Lamp Lumens	N.A. (absolute)
Luminaire Lumens	822
Total Luminaire Efficiency	N.A.
Luminaire Efficacy Rating (LER)	69
Total Luminaire Watts	12
Ballast Factor	1.00
CIE Type	Direct
Spacing Criterion (0-180)	0.54
Spacing Criterion (90-270)	0.54
Spacing Criterion (Diagonal)	0.66
Basic Luminous Shape	Circular
Luminous Length (0-180)	0.00 ft
Luminous Width (90-270)	0.33 ft (Diameter)
Luminous Height	0.00 ft

Zonal Lumen Summary

Zone	Lumens
0-10	118.09
10-20	222.35
20-30	222.97
30-40	213.89
40-50	35.20
50-60	5.08
60-70	3.30
70-80	1.07
80-90	0.21
90-100	0.00
100-110	0.00
110-120	0.00
120-130	0.00
130-140	0.00
140-150	0.00
150-160	0.00
160-170	0.00
170-180	0.00

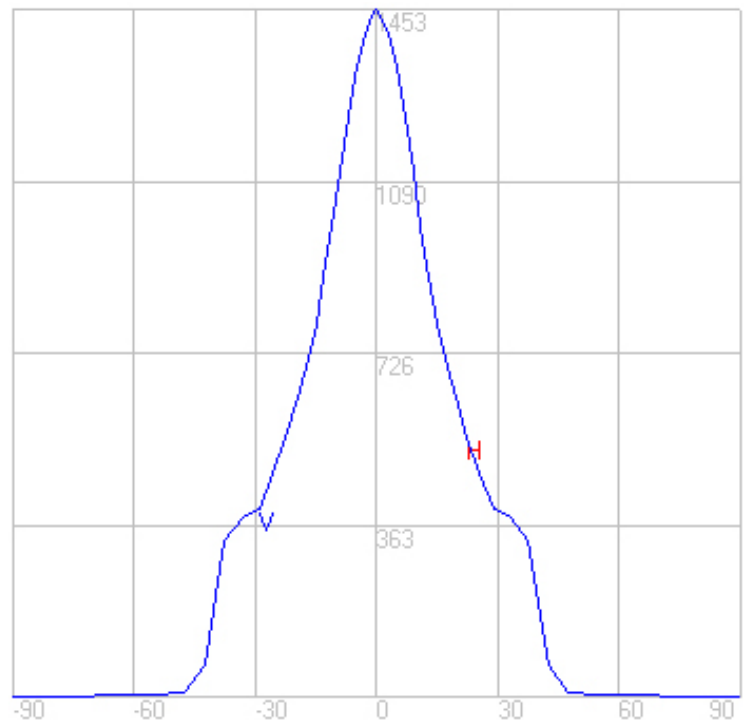
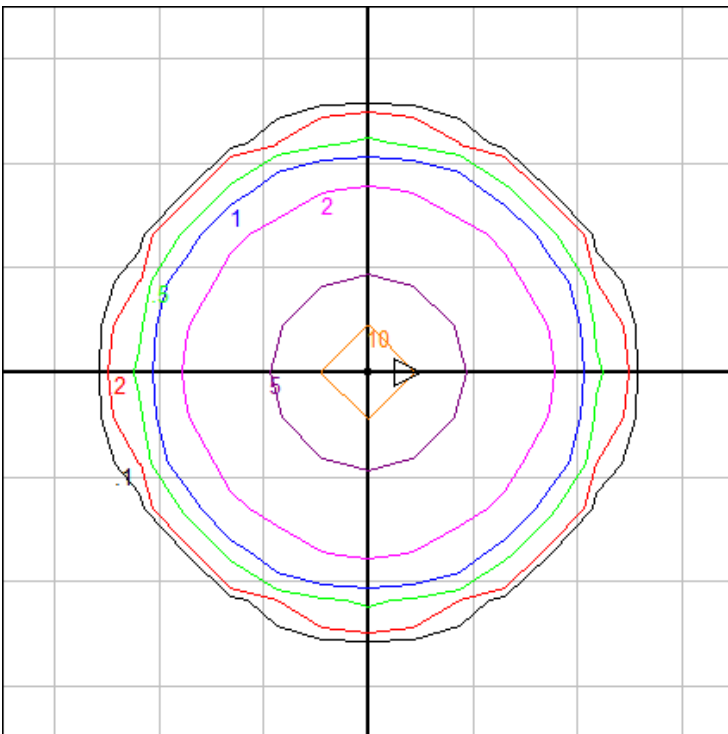

Mounting Height: 10 ft.

Grid Spacing: 4 ft.

In the interest of product improvement, BEGA reserves the right to make technical changes without notice.

BEGA 1000 Bega Way, Carpinteria, CA 93013 (805)684-0533 Fax (805)566-9474 www.bega-us.com © Copyright BEGA-US 2020

08/06/20

BEGA

File: 50684.6K35_BEGA_IES.ies

TEST: BE_50684.6K3
 TEST LAB: BEGA
 DATE: 11/26/2018
 LUMINAIRE: 50 684.6K35
 LAMP: 8.1W LED

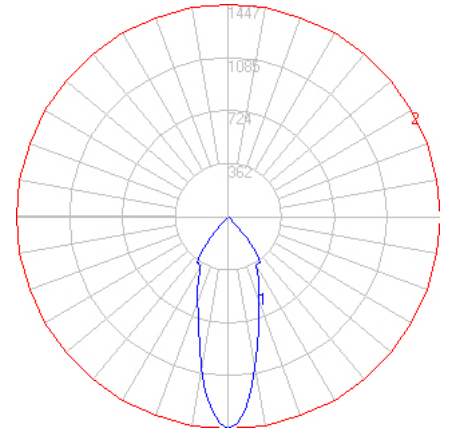
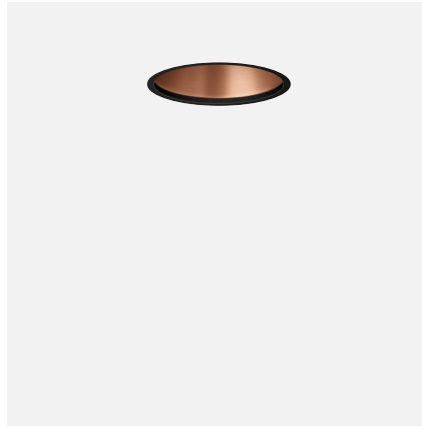

Characteristics

Lumens Per Lamp	N.A. (absolute)
Total Lamp Lumens	N.A. (absolute)
Luminaire Lumens	819
Total Luminaire Efficiency	N.A.
Luminaire Efficacy Rating (LER)	68
Total Luminaire Watts	12
Ballast Factor	1.00
CIE Type	Direct
Spacing Criterion (0-180)	0.54
Spacing Criterion (90-270)	0.54
Spacing Criterion (Diagonal)	0.66
Basic Luminous Shape	Circular
Luminous Length (0-180)	0.00 ft
Luminous Width (90-270)	0.33 ft (Diameter)
Luminous Height	0.00 ft

Zonal Lumen Summary

Zone	Lumens
0-10	117.62
10-20	221.48
20-30	222.09
30-40	213.05
40-50	35.06
50-60	5.06
60-70	3.29
70-80	1.06
80-90	0.21
90-100	0.00
100-110	0.00
110-120	0.00
120-130	0.00
130-140	0.00
140-150	0.00
150-160	0.00
160-170	0.00
170-180	0.00

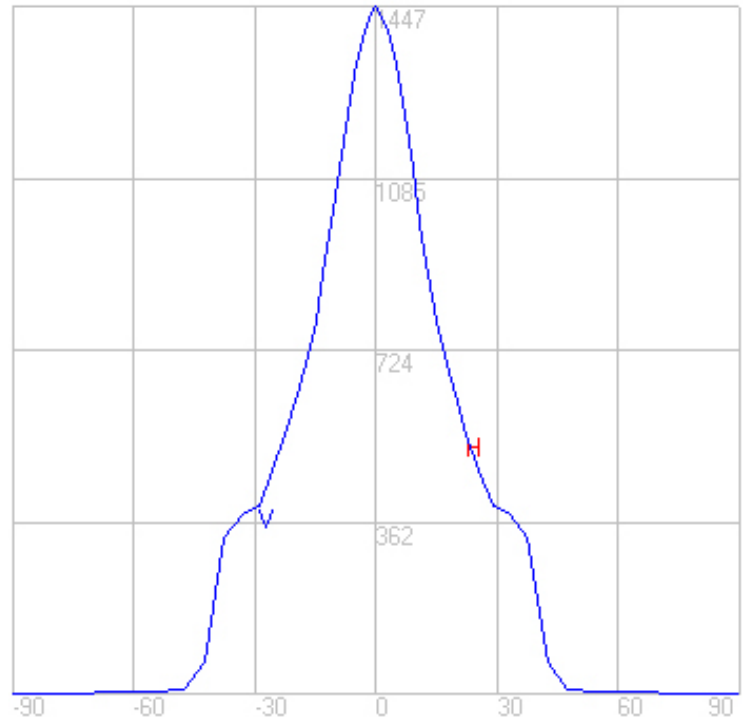
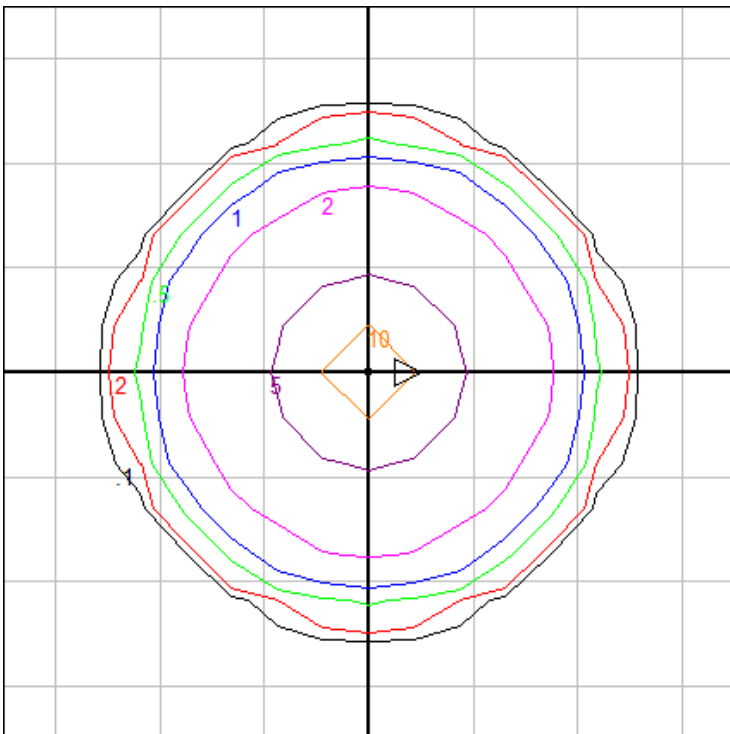

Mounting Height: 10 ft.

Grid Spacing: 4 ft.

In the interest of product improvement, BEGA reserves the right to make technical changes without notice.

BEGA 1000 Bega Way, Carpinteria, CA 93013 (805)684-0533 Fax (805)566-9474 www.bega-us.com © Copyright BEGA-US 2020

08/06/20

BEGA

File: 50684.6K3_BEGA_IES.ies

TEST: BE_50684.6K3
 TEST LAB: BEGA
 DATE: 11/26/2018
 LUMINAIRE: 50 684.6K3
 LAMP: 8.1W LED

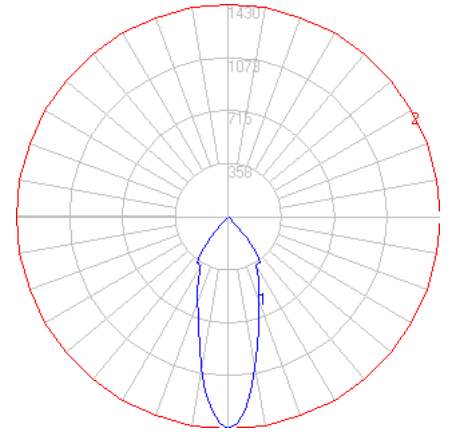
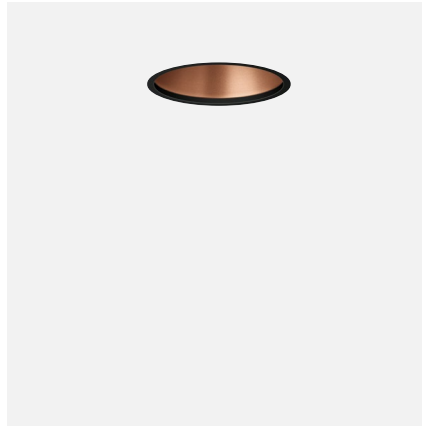

Characteristics

Lumens Per Lamp	N.A. (absolute)
Total Lamp Lumens	N.A. (absolute)
Luminaire Lumens	809
Total Luminaire Efficiency	N.A.
Luminaire Efficacy Rating (LER)	67
Total Luminaire Watts	12
Ballast Factor	1.00
CIE Type	Direct
Spacing Criterion (0-180)	0.54
Spacing Criterion (90-270)	0.54
Spacing Criterion (Diagonal)	0.66
Basic Luminous Shape	Circular
Luminous Length (0-180)	0.00 ft
Luminous Width (90-270)	0.33 ft (Diameter)
Luminous Height	0.00 ft

Zonal Lumen Summary

Zone	Lumens
0-10	116.23
10-20	218.85
20-30	219.46
30-40	210.52
40-50	34.64
50-60	5.00
60-70	3.25
70-80	1.05
80-90	0.20
90-100	0.00
100-110	0.00
110-120	0.00
120-130	0.00
130-140	0.00
140-150	0.00
150-160	0.00
160-170	0.00
170-180	0.00

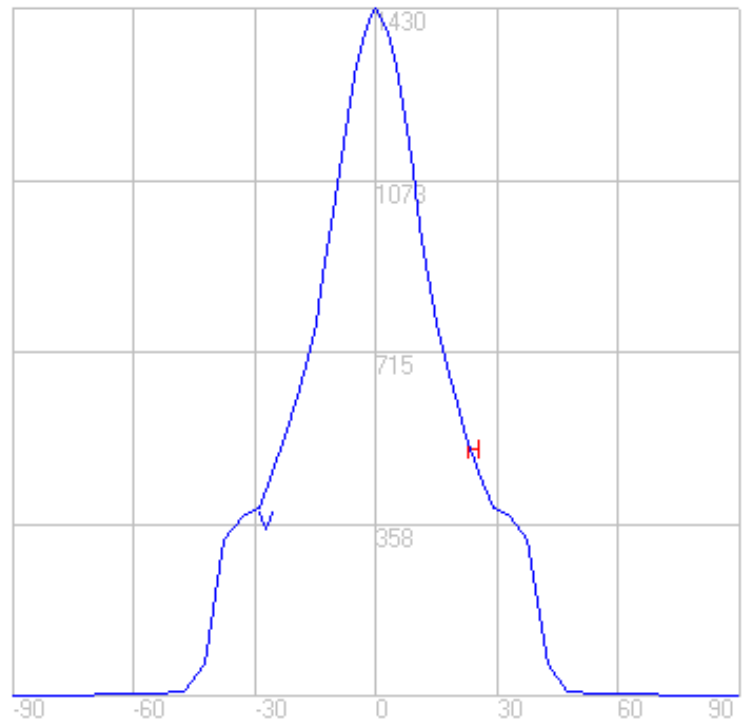
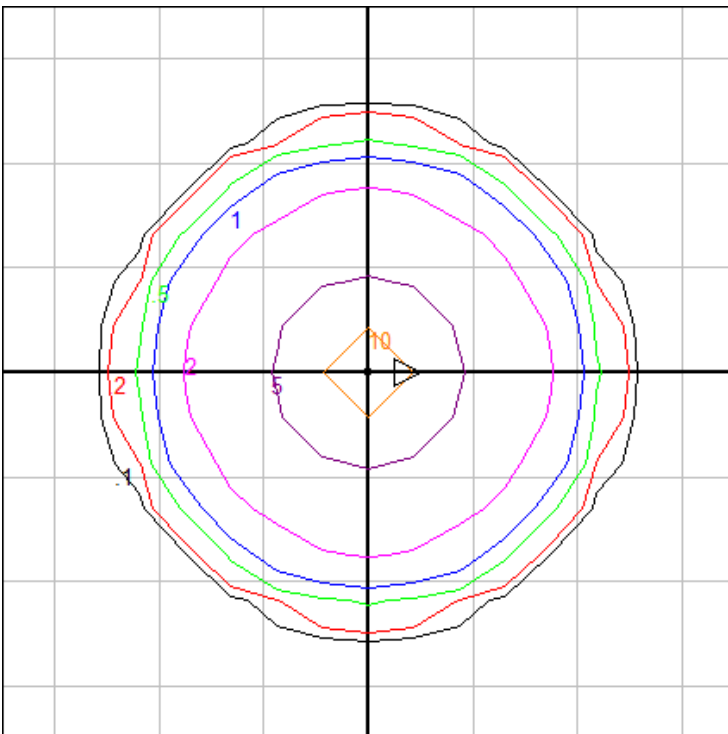

Mounting Height: 10 ft.

Grid Spacing: 4 ft.

In the interest of product improvement, BEGA reserves the right to make technical changes without notice.

BEGA 1000 Bega Way, Carpinteria, CA 93013 (805)684-0533 Fax (805)566-9474 www.bega-us.com © Copyright BEGA-US 2020

08/06/20

BEGA

File: 50684.6K27_BEGA_IES.ies

TEST: BE_50684.6K3
 TEST LAB: BEGA
 DATE: 11/26/2018
 LUMINAIRE: 50 684.6K27
 LAMP: 8.1W LED

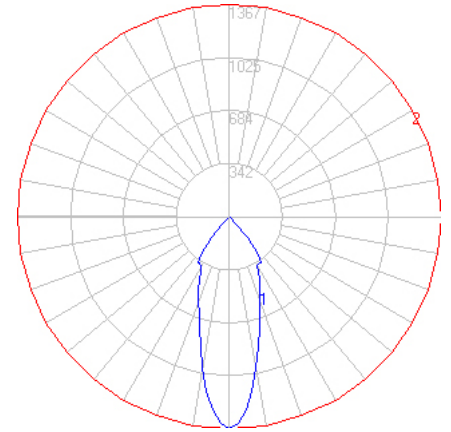
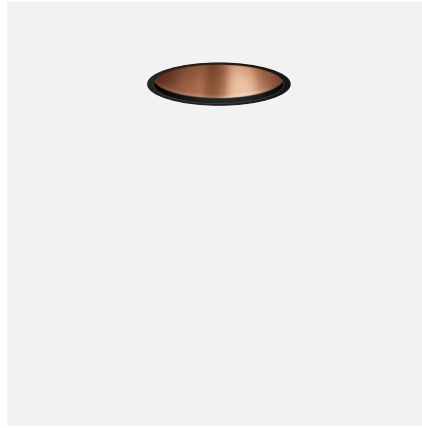

Characteristics

Lumens Per Lamp	N.A. (absolute)
Total Lamp Lumens	N.A. (absolute)
Luminaire Lumens	774
Total Luminaire Efficiency	N.A.
Luminaire Efficacy Rating (LER)	65
Total Luminaire Watts	12
Ballast Factor	1.00
CIE Type	Direct
Spacing Criterion (0-180)	0.54
Spacing Criterion (90-270)	0.54
Spacing Criterion (Diagonal)	0.66
Basic Luminous Shape	Circular
Luminous Length (0-180)	0.00 ft
Luminous Width (90-270)	0.33 ft (Diameter)
Luminous Height	0.00 ft

Zonal Lumen Summary

Zone	Lumens
0-10	111.12
10-20	209.22
20-30	209.80
30-40	201.26
40-50	33.12
50-60	4.78
60-70	3.11
70-80	1.00
80-90	0.20
90-100	0.00
100-110	0.00
110-120	0.00
120-130	0.00
130-140	0.00
140-150	0.00
150-160	0.00
160-170	0.00
170-180	0.00

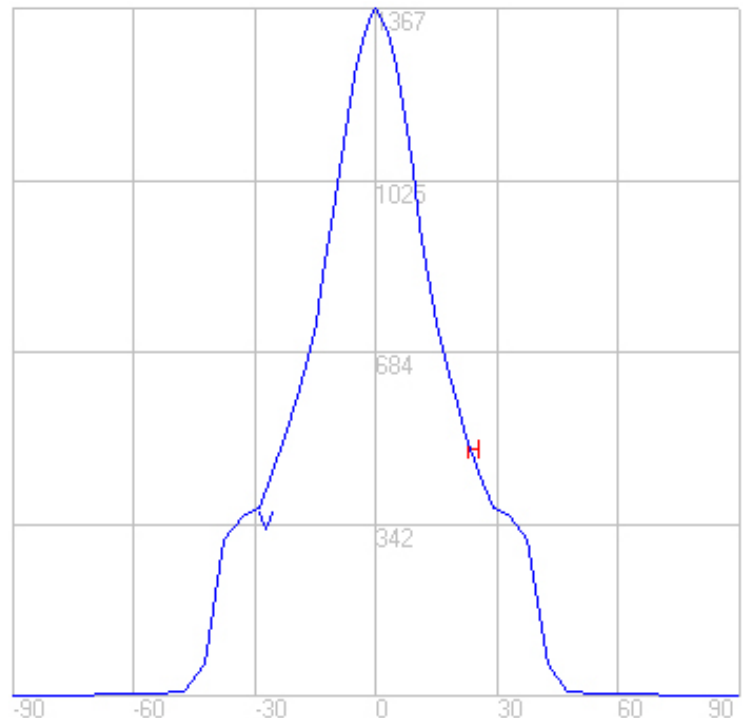
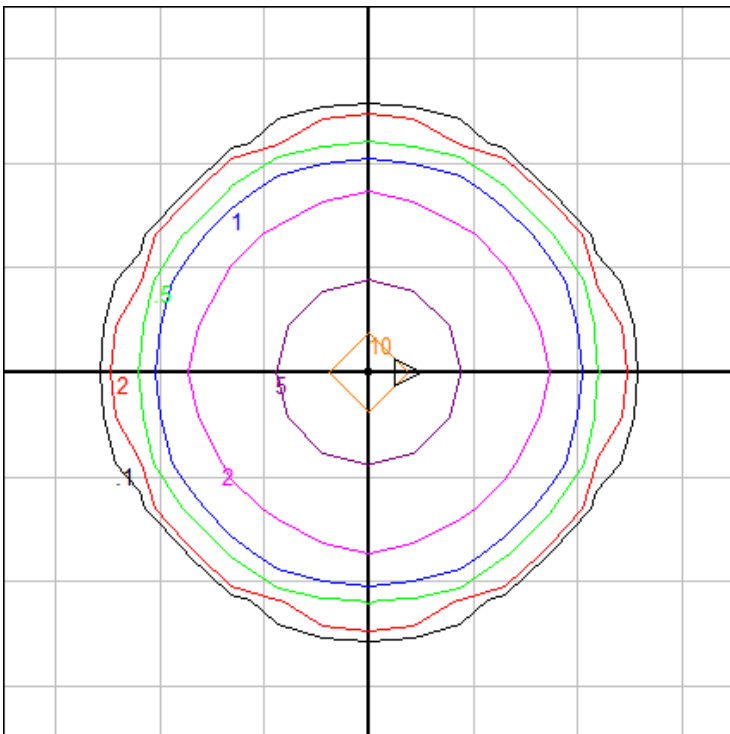

Mounting Height: 10 ft.

Grid Spacing: 4 ft.

In the interest of product improvement, BEGA reserves the right to make technical changes without notice.

BEGA 1000 Bega Way, Carpinteria, CA 93013 (805)684-0533 Fax (805)566-9474 www.bega-us.com © Copyright BEGA-US 2020

08/06/20