

NOTE: CEILING MOUNTED LUMINAIRE # 50 513.X – SEE SPECIFICATIONS

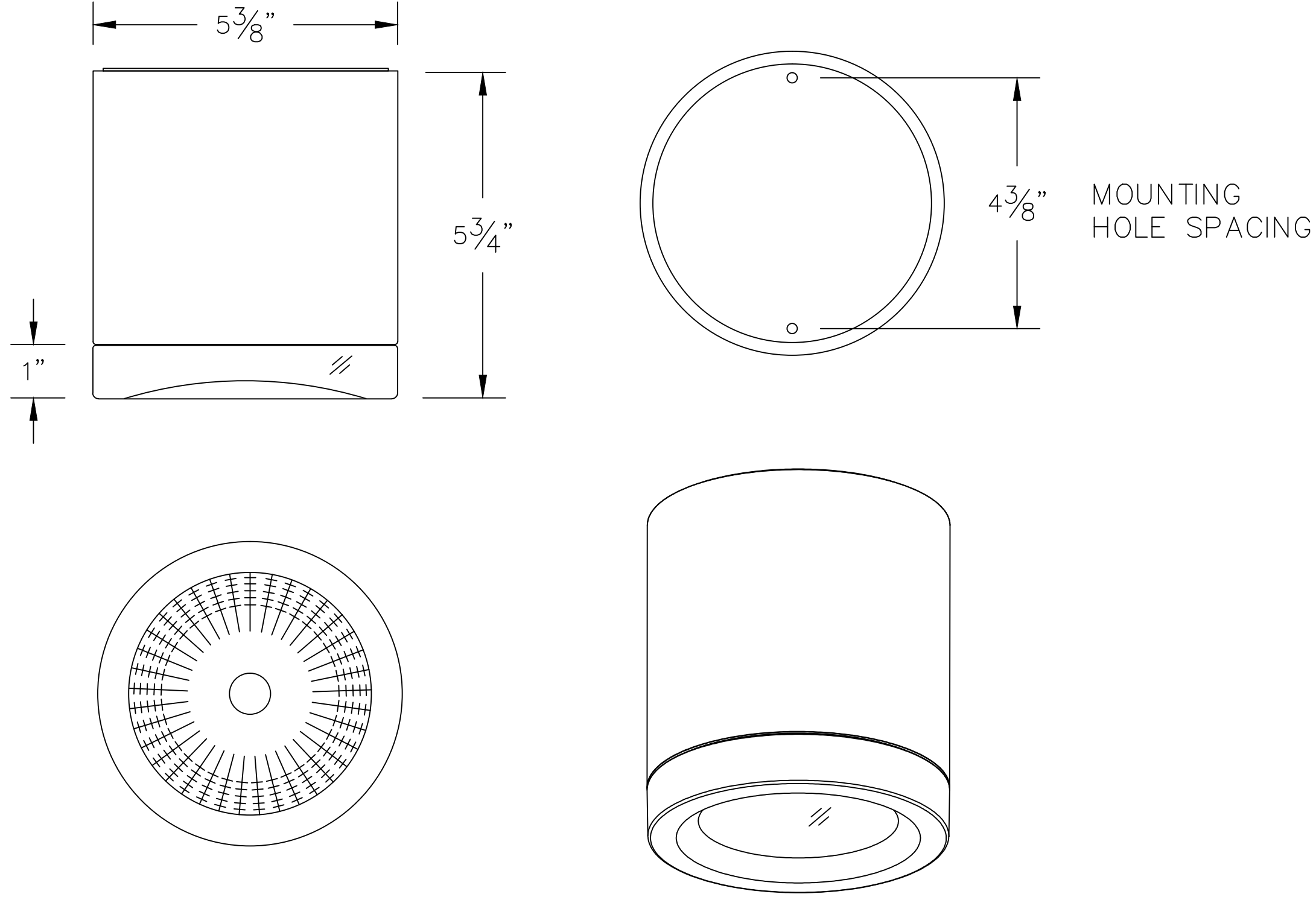

TYPE: _____

SUBMITTAL APPROVAL

APPROVED BY: _____ DATE: _____
 SIGNED: _____

REV.	DATE	DESCRIPTION

CAT NO.: 50 513.X

PROJECT: -

LOCATION: -

DRAWN: AG DATE: 10/30/2018 FILE NAME: 50513.dxf

BEGA

1000 Bega Way
 Carpinteria, Ca. 93013
 (805) 684-0533