

NOTE:

- LUMINAIRE # 50 368 – SEE SPECIFICATIONS

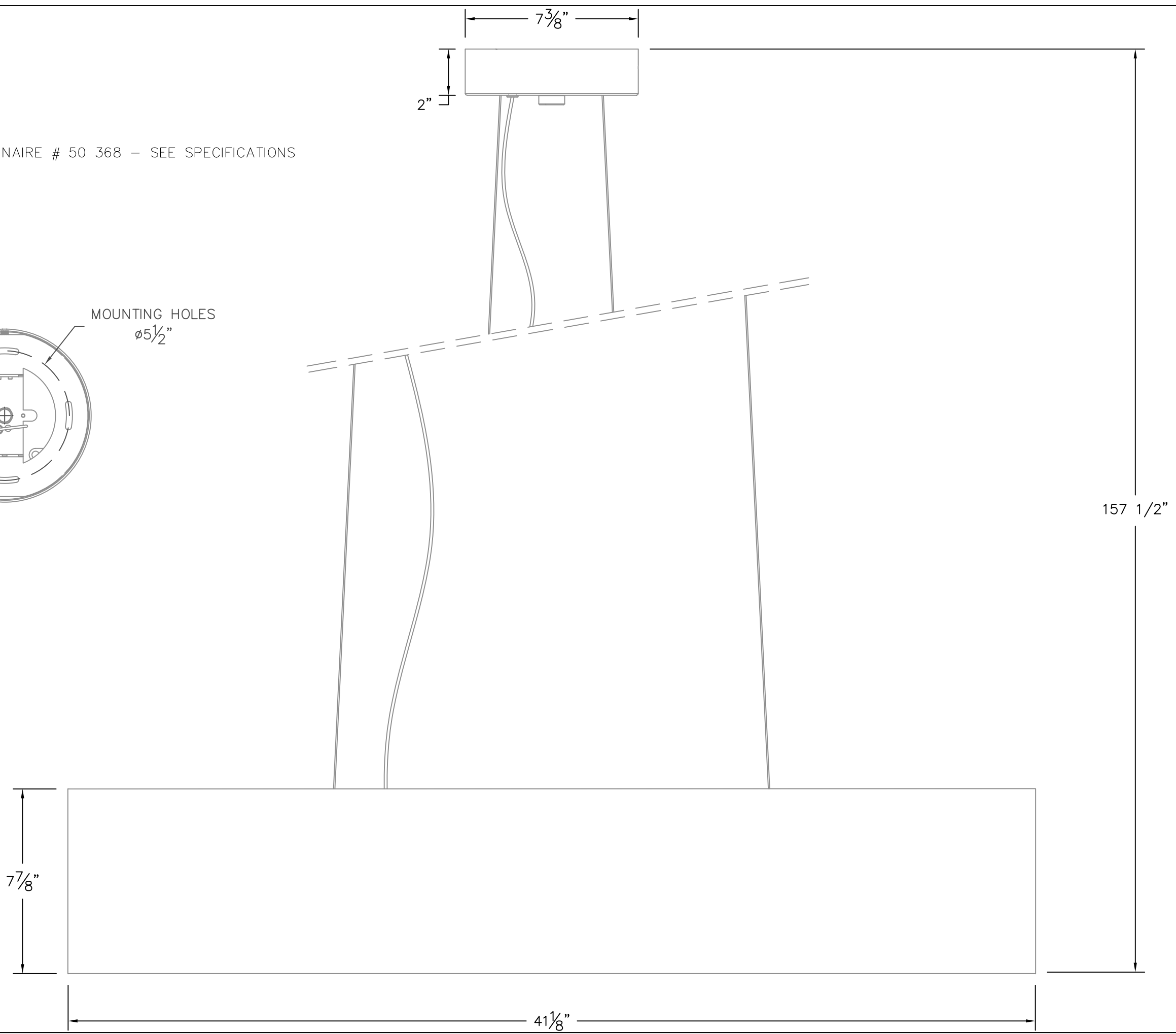
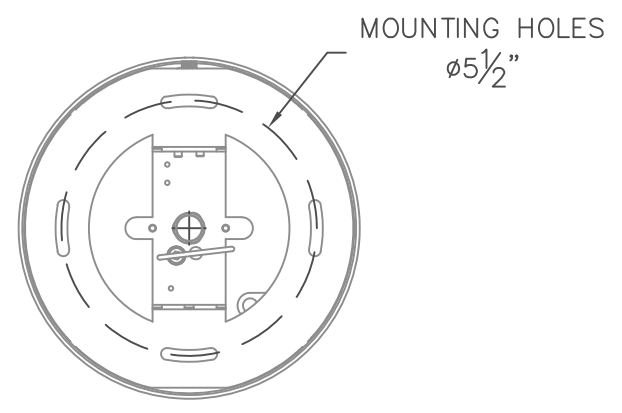

SUBMITTAL APPROVAL

APPROVED BY: _____ DATE: _____
SIGNED: _____

REV.	DATE	DESCRIPTION

CAT NO.: 50368_BEGA_SUBMITTAL

PROJECT: _____

LOCATION: _____

DRAWN:MPRENGEBATE:7/14/2020 FILE NAME:50368_BEGA_SUBMITTAL.DXF

BEGA

1000 Bega Way
Carpinteria, Ca. 93013
(805) 684-0533

This print contains confidential information which is the property of BEGA U.S. By acceptance this information, the borrower agrees that it will not be used for any other purpose other than that which is loaned.