

Tools Required:

- Torx T20 screwdriver
- Medium Phillips screwdriver

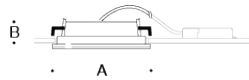

Dimensions

- A:** 7-1/4"
B: 2-3/8"

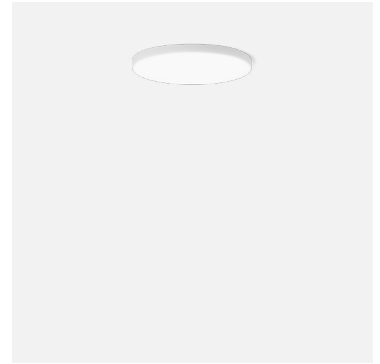

Overview:

- LED Watts: 8.5W
 System Watts: 13.0W
 Controllability: DALI-2 Controlled
 Weight: 2.2 lbs.

Notice to Installer:

1. See page 3 for specific product safety warnings.
2. Luminaire not suitable for poured concrete construction.
3. Luminaire is non-IC rated. Insulation must be at least 3" from luminaire housing.
4. Minimum ceiling clearance is 7" to fit ceiling box.
5. Ceiling/Wall thickness must be between 1/4" and 3/4".
6. Cut out diameter is 6 5/16"
7. Ceiling box with driver included (Figure 1)
8. BEGA Tunable White luminaires require commissioning by a professional familiar with DALI-2 controls for proper operation.

CEILINGBOX (Ceiling) Installation:

1. Fixture is connected to ceilingbox via quick-disconnect. Disconnect fixture and ceilingbox.
2. Press down spring tab to release the cover of the ceilingbox.
3. Bring supply wiring into ceiling box via 7/8" diameter conduit entry points located on the ceilingbox.
 MAIN VOLTAGE SUPPLY WIRE TO BLACK DRIVER WIRE(S);
 NEUTRAL (COMMON SUPPLY WIRE TO WHITE DRIVER WIRE(S);
 GREEN GROUND WIRE TO GREEN DRIVER WIRE(S).
 DALI-2 Control wiring (if applicable):
 DIMMING CONTROL WIRE (+) TO POSITIVE DRIVER DALI CONTROL WIRE
 DIMMING CONTROL WIRE (-) TO NEGATIVE DRIVER DALI CONTROL WIRE
4. Place & latch the ceilingbox cover back into place.
5. Push the ceiling box through the ceiling cut-out. The ceiling box will rest on ceiling construction material.
6. See page 2 for luminaire installation.

CEILINGBOX (Wall) Installation:

1. Follow steps 1-4 of CEILINGBOX (Ceiling) Installation.
2. Place CEILINGBOX into cutout in wall.
3. CEILINGBOX will be provided with mounting tabs to mount CEILINGBOX to framing within wall. (mounting hardware provided by others)
4. See page 3 for luminaire installation.

Note: Minimum ceiling clearance of 7" is required to fit ceiling box.

Figure 1: Ceilingbox Installation (Generic Image)

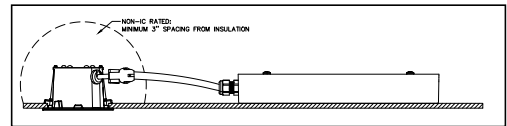
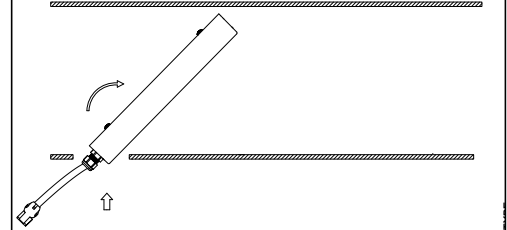

Figure 2: Glass Removal (Generic Image)

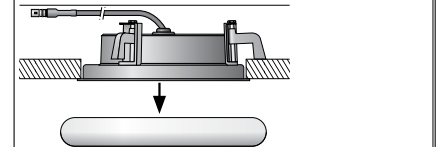
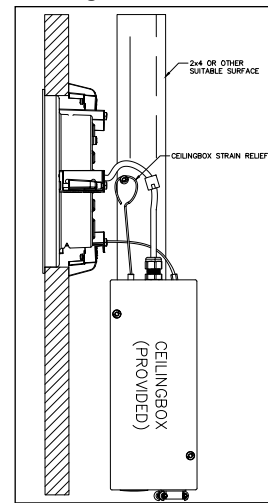

Figure 3: Ceilingbox Wall Installation (Generic Image)



Accessories

Please refer to the appropriate accessory installation sheet for further instruction when applicable.

Maintenance:

Clean regularly with solvent-free cleaner removing dirt and debris. Do not use high pressure cleaners.

Replacement Parts

See label inside of fixture for LED replacement part number.

Consult factory for all other replacement components.

Tools Required:

Phillips medium flat head screw driver
T20 TORX Head

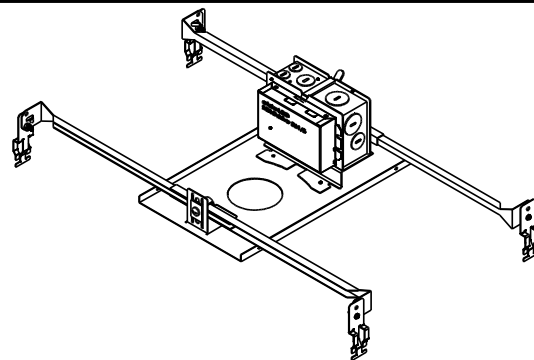

Overview: Ceiling Pan

Rating: Non-IC
Ceiling Thickness: 1/2" Min - 3/4" Max
Min Ceiling Clearance: 4 5/8"
Ceiling Cutout: 6 9/16"
Driver Location: Ceiling Pan
Controllability: DALI-2 controlled

Optional Ceiling Pan:

Notice to Installer:

1. See page 3 for specific product safety warnings.
2. Luminaire is non-IC rated. Insulation must be at least 3" from luminaire housing.
3. Minimum ceiling clearance is 4 5/8".
4. Ceiling thickness must be between 1/2" and 3/4".
5. Ceiling cut out is 6 9/16"
6. Driver (included) located on ceiling pan
7. BEGA Tunable White luminaires require commissioning by a professional familiar with DALI-2 controls for proper operation.
8. LEDs are high-quality electronic components! Please avoid touching LED directly during installation.

Installation: Ceiling pan

1. Attach ceiling pan to T-bar using (4) (included) snap-on brackets.
2. Level rough-in kit so bottom of pan will sit on top of ceiling material.
3. Bring supply wiring in to junction box and make connections from supply wires to driver wires:
MAIN VOLTAGE SUPPLY WIRE TO BLACK DRIVER WIRE(S);
NEUTRAL (COMMON SUPPLY WIRE TO WHITE DRIVER WIRE(S);
GREEN GROUND WIRE TO GREEN DRIVER WIRE(S).
- DALI Control wiring:
CONTROL WIRE (+) TO POSITIVE DRIVER DALI CONTROL WIRE
CONTROL WIRE (-) TO NEGATIVE DRIVER DALI CONTROL WIRE

50 293 Installation:

1. Connect quick-disconnect and tethered aircraft cable between the ceiling box and luminaire housing.
2. Push rough-in housing into opening in ceiling/wall. Rough-in housing is held into place with (3) wedge-shaped claws. If ceiling/wall is less than 1/4" thick, reinforcement must be used to allow claws to engage with back side of ceiling surface.
3. Evenly tighten T20 TORX head screws to engage wedge-shaped claws.
4. Screw glass with gasket into the luminaire housing, ensuring gasket is seated evenly.

Accessories

Please refer to the appropriate accessory installation sheet for further instruction when applicable.

Maintenance:

Clean regularly with solvent-free cleaner removing dirt and debris. Do not use high pressure cleaners.

Replacement Parts

See label inside of fixture for LED replacement part number.
Consult factory for all other replacement components.

Product Safety Warnings:

THIS PRODUCT MUST BE INSTALLED IN ACCORDANCE WITH THE APPLICABLE INSTALLATION CODE BY A PERSON FAMILIAR WITH THE CONSTRUCTION AND OPERATION OF THE PRODUCT AND THE HAZARDS INVOLVED. SUITABLE FOR DAMP LOCATIONS. MIN 90°C SUPPLY CONDUCTORS.

CE PRODUIT DOIT ÊTRE INSTALLÉ SELON LE CODE D'INSTALLATION PERTINENT, PAR UNE PERSONNE QUI CONNAÎT BIEN LE PRODUIT ET SON FONCTIONNEMENT AINSI QUE LES RISQUES INHÉRENTS. CONVIENT AUX EMPLACEMENTS HUMIDE.

LES FILS D'ALIMENTATION 90°C MIN.