

Tools Required:

- Hex key
- Philips medium screwdriver



Dimensions

- A:** 27-3/4 "
- B:** 3-1/8 "
- C:** 4-1/2 "



Weight: 7.28 lbs.

Notice to Installer for 50 069:

1. See page 2 for specific product safety warnings.
2. For wall applications only.
3. For attachment to wall over separate small opening linear wiring box (19 537 provided by BEGA).
4. NOTE: LEDs are high-quality electronic components! Please avoid touching them directly during installation.
5. Carefully secure glass before removing luminaire end cap during installation, as it is detached from opposite end of base.

NOTE: LEDs are high-quality electronic components! Please avoid touching them directly during installation.

50 069 - 19 537 wiring box installation:

Hollow (stud) wall construction - Secure wiring box to wood or metal horizontal blocking as shown in the submittal drawings. Connect conduit to wiring box (if needed) and pull wires for electrical connections to be made later.

Poured concrete construction - Attach wiring box to the concrete form. Connect conduit to wiring box (if needed) and pull wires for electrical connections to be made later. Pour concrete and remove form.

IMPORTANT: Do not pour concrete directly onto box!

50 069 - installation:

1. Undo set screw in luminaire cap and carefully remove glass lens from luminaire base.
2. Feed connector supply wiring through luminaire base.
3. Make supply wiring connections inside the linear wiring box:
 MAIN VOLTAGE SUPPLY WIRE TO BLACK LUMINAIRE WIRE
 NEUTRAL (COMMON) SUPPLY WIRE TO WHITE LUMINAIRE WIRE
 GREEN GROUND WIRE TO GREEN LUMINAIRE WIRE.
- Dimming (if applicable):**
 DIMMING CONTROL WIRE (+) TO POSITIVE DRIVER DIM CONTROL WIRE
 DIMMING CONTROL WIRE (-) TO NEGATIVE DRIVER DIM CONTROL WIRE
4. Attach the luminaire base directly to the wall using appropriate hardware (by others).
5. Replace lens and lock into place by tightening set screw.

Figure 1

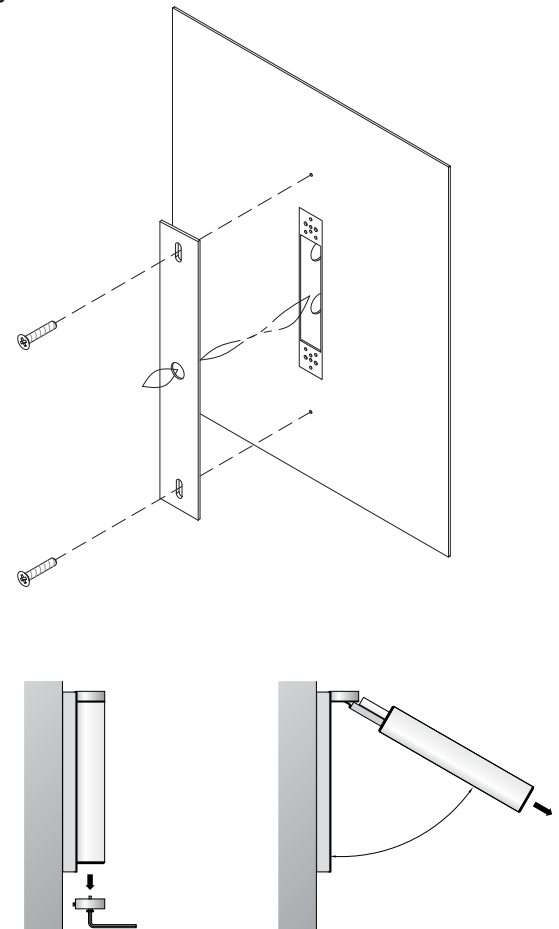

Relamping/Maintenance

Unscrew lens from luminaire base. Clean glass and luminaire using only solvent-free cleansers. Replace lens.

Accessories

Please refer to the appropriate accessory installation sheet for further instruction when applicable.

Linear Wiring Box 19 537

Replacement Parts

Description	Part No
Glass	112764.1
LED driver (120-277V)	75969-01
LED module (3000K) (x4)	LED-0627/930
LED module (4000K) (x4)	LED-0627/940

Lamp: 23.6W LED Module

In the interest of product improvement, BEGA reserves the right to make technical changes without notice.

Product Safety Warnings:

THIS PRODUCT MUST BE INSTALLED IN ACCORDANCE WITH THE APPLICABLE INSTALLATION CODE BY A PERSON FAMILIAR WITH THE CONSTRUCTION AND OPERATION OF THE PRODUCT AND THE HAZARDS INVOLVED. SUITABLE FOR DAMP LOCATIONS.

MIN 90°C SUPPLY CONDUCTORS.

CE PRODUIT DOIT ÊTRE INSTALLÉ SELON LE CODE D'INSTALLATION PERTINENT, PAR UNE PERSONNE QUI CONNAÎT BIEN LE PRODUIT ET SON FONCTIONNEMENT AINSI QUE LES RISQUES INHÉRENTS. CONVIENT AUX EMPLACEMENTS HUMIDES.

LES FILS D'ALIMENTATION 90°C MIN.
