

Tools Required:

- 3mm and 4mm Hex Key
- Philips medium screw driver
- Medium slotted screw driver

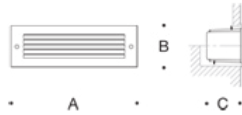

Dimensions

- A:** 7 1/2 "
- B:** 3 1/8 "
- C:** 4 "



Protection Class: IP64

Weight: 4.5 lbs.

Notice to Installer for 22 135:

1. **BEGA luminaires may be damaged if connected to conduit systems containing water - Article 300-5G of National Electric Code requires that "Conduits or raceways through which moisture may contact energized live parts shall be sealed or plugged at either or both ends".**
2. Backbox is Non-IC rated.
3. Suitable for all types of construction including poured concrete construction.
4. Back housing provided with (2) 1/2" NPT threaded holes (horizontal entry). **IMPORTANT: USE 1/2" NPT FITTING AND TEFLON TAPE AT CONDUIT - BACK HOUSING CONNECTION IN ORDER TO PROPERLY SEAL BACK HOUSING.**
5. **Back housing MUST be installed so that the front face is flush with or slightly protruded from the finished wall. Failure to do so will result in the faceplate not sealing properly, and will void the BEGA warranty.**
6. Suitable for through wiring: max. of (4) No. 12 AWG conductors (plus ground) rated for 75°C.
7. Suitable for wall applications only. (No ceiling and in-grade applications.)
8. Wet location listing does not imply suitability for installation in wall cores where fixture may be exposed to standing or running water.
9. The maximum thickness for installation wall or finished surface/veneer is not to exceed 5/8".
10. The front face of the housing is a gasket sealing surface; care must be taken to ensure that this surface remains clean and free of debris.

BB22 033 back housing installation in hollow (stud) wall construction (2" x 6" min.):

1. Install the (2) slotted mounting brackets provided as shown in Figure 1, using the (4) 8-32 screws provided.
2. Adjust the brackets (by loosening the screws) so that the front face of the back box will be flush or slightly in front of the finished wall surface after installation (see Figure 2).
3. Orient fixture housing as directed on label. Failure to do so will result in faceplate not installing properly.
4. Secure the mounting brackets to wood or metal blocking (hardware by others) as shown in Figure 2.
5. Connect conduit to back housing using 1/2" NPT fitting with teflon tape on conduit or back housing threads. Pull wires into back housing for electrical connections to be made later.
6. Install splatter guard securely and finish wall.
7. Place a small bead of silicone between edge of housing and wall to provide a seal.
8. Before continuing, remove splatter guard and debris from sealing surface.

BB22 033 back housing installation in brick wall construction:

1. Install the (2) slotted mounting brackets provided as shown in Figure 3, using the (4) 8-32 screws provided.
2. Adjust the brackets vertically for optimal gap spaces between upper and lower brick surfaces and back housing
3. Orient fixture housing as directed on label. Failure to do so will result in faceplate not installing properly.
4. Secure the mounting brackets to the top of the brick (hardware by others) so that the front face of the back box will be flush or slightly in front of the finished wall surface after installation (see Figure 3).
5. Connect conduit to back housing using 1/2" NPT fitting with teflon tape on conduit or backhousing threads. Pull wires into back housing for electrical connections to be made later.
6. Install splatter guard and finish wall.
7. Place a small bead of silicone between edge of housing and wall to provide a seal.
8. Before continuing, remove splatter guard and debris from sealing surface.

Figure 1 (stud wall)

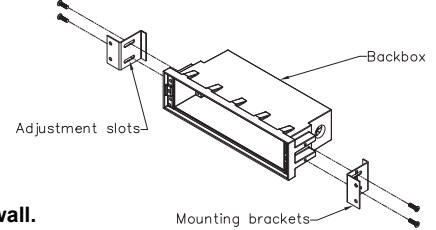

Figure 2 (stud wall)

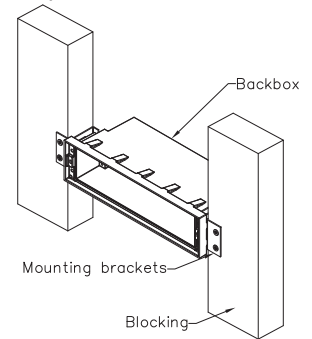
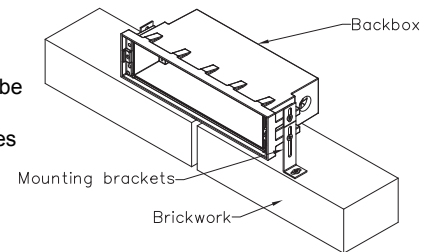

Figure 3 (brick wall)



Relamping/Maintenance

No relamping required.

Accessories

Please refer to the appropriate accessory installation sheet for further instruction when applicable.

Replacement Parts

Description	Part No
Faceplate	FP2035
Gasket (Back housing)	83107
Driver (120V-277V)	76023

Lamp: 3W LED Module

In the interest of product improvement, BEGA reserves the right to make technical changes without notice.

Tools Required:

- 3mm and 4mm Hex Key
- Philips medium screw driver
- Medium slotted screw driver

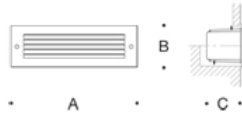

Dimensions

- A: 7 1/2 "
- B: 3 1/8 "
- C: 4 "



Protection Class: IP64

Weight: 4.5 lbs.

BB22 033 back housing installation in poured concrete construction:

1. Install (4) threaded 10-24 rods (supplied) in face of the back housing. Hand tighten until secure (See Figures 1 and 2).
2. Attach back housing to form using (4) wing nuts provided so that the front face of the back housing will be flush or slightly in front of the finished surface.
3. Orient fixture housing as directed on label. Failure to do so will result in faceplate not installing properly.
4. Connect conduit to back housing using 1/2" NPT fitting with teflon tape on conduit or back housing threads. Pull wires into back housing for electrical connections to be made later.
5. Pour concrete. NOTE: DO NOT PUMP OR DROP CONCRETE DIRECTLY ON TOP OF THE BACK HOUSING.
6. Remove the wing nuts and threaded rods before removing form. IMPORTANT: FULLY UNTHREAD AND REMOVE MOUNTING RODS FROM BACK HOUSING. DO NOT CUT OR SHEAR MOUNTING RODS AS THIS MAY COMPROMISE FACEPLATE SEAL TO THE BACK HOUSING.
7. Install splatter guard to protect during construction.
8. Place a small bead of silicone between edge of housing and wall to provide a watertight seal.
9. Before continuing, remove splatter guard and debris from sealing surface.

Figure 1 (poured concrete)

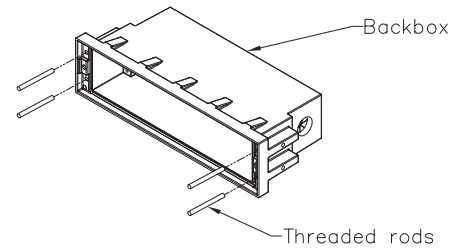

22 135 Installation:

1. Place a small bead of silicone between edge of housing and wall to provide a seal.
2. Before continuing, remove splatter guard and debris from sealing surface.
3. Orient gear tray (BP ballast plate) as directed on labels, to ensure proper light distribution.
4. Make supply wiring connections to gear tray wires:
 - MAIN VOLTAGE SUPPLY WIRE TO BLACK BALLAST WIRE
 - NEUTRAL (COMMON) SUPPLY WIRE TO WHITE BALLAST WIRE
 - GREEN GROUND WIRE TO GREEN BALLAST WIRE
5. Install gear tray in the back housing using (4) 6-32 screws.
6. Install faceplate, making sure the gasket is seated properly. Tighten (2) 3mm hex screws evenly.

Figure 2 (poured concrete)

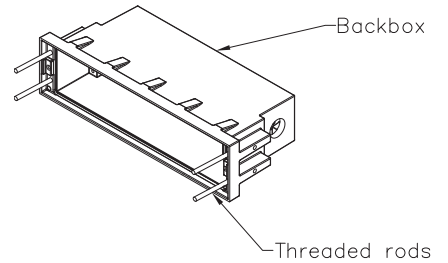

Relamping/Maintenance

No relamping required.

Accessories

Please refer to the appropriate accessory installation sheet for further instruction when applicable.

Replacement Parts

Description	Part No
Faceplate	FP2035
Gasket (Back housing)	83107
Driver (120V-277V)	76023

Lamp: 3W LED Module

In the interest of product improvement, BEGA reserves the right to make technical changes without notice.